

- Standard Voltage to 250 V AC/400 V DC, 3 A
- Cable Assemblies
- Cable Connectors
- PCB Connectors
- Guaranteed Compatibility



Simple Connection

Pickering connection solutions provide a simple way of connecting to a user's device under test or remote connection. The products include cable assemblies, cable connectors and pcb connectors.

Cable Assemblies

Cable assemblies are offered in connector to connector, and connector to unterminated versions. There are 3 termination options for the unterminated cables - ferrules, tinned copper or simple cut end.

Custom Design Needs

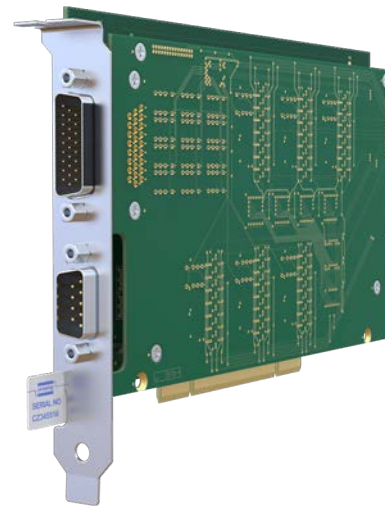
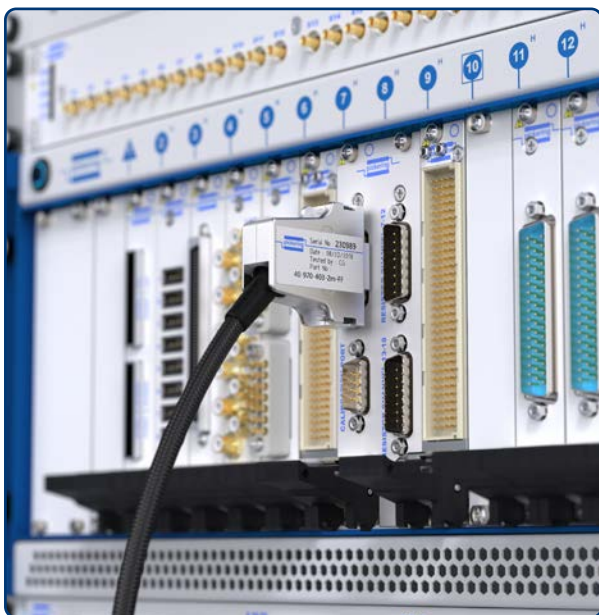

Pickering Interfaces can manufacture custom connector accessories to suit any application. If you do not see what you need in this data sheet contact your Pickering Interfaces sales office with information on your requirements or consider using our free online Cable Design Tool.

Using our Cable Design Tool, you can graphically design your own custom cable assembly. Once completed and submitted, our engineers will generate a quote for your cable requirements. See pickeringtest.com/cdt





Examples of Pickering PXI and PCI Products using 26-Pin D-type Connectors

Cable Assemblies



Description		End 1	End 2		Cable Length	Product Order Code and Part Number	Data Sheet Page
		Gender & Cable Exit	Gender & Cable Exit	Options			
	Cable Assy, 26-Pin D-Type, 3 A	Male, 45° Towards Pin 1	Female, 45° Away from Pin 1	-	0.5 m 1 m 2 m	40-970-026-0.5m-MF 40-970-026-1m-MF 40-970-026-2m-MF	4
		Female, 45° Away from Pin 1	Female, 45° Away from Pin 1	-	0.5 m 1 m 2 m	40-970-026-0.5m-FF 40-970-026-1m-FF 40-970-026-2m-FF	5
	Cable Assy, 26-Pin D-Type to Underterminated, 3 A	Female, 45° Away from Pin 1	NA	Ferrules	0.5 m 1 m 2 m	40-972-026-0.5m-FU 40-972-026-1m-FU 40-972-026-2m-FU	6
				Tinned End	0.5 m 1 m 2 m	A026HF4-T-0A050 A026HF4-T-0A100 A026HF4-T-0A200	
				Cut End	0.5 m 1 m 2 m	A026HF4-C-0A050 A026HF4-C-0A100 A026HF4-C-0A200	

Note: Custom lengths by quotation

Female Connectors

Description		Gender & Cable Exit	Type	Product Order Code and Part Number	Page
	Cable Connector 26-Pin D-Type, 3 A, Solder Bucket	Female, 45° Options	With Backshell	40-960-026-F	7
			Without Backshell	92-960-026-F	
	PCB Connector 26-Pin D-Type, 5 A	Female	Right Angle PCB Mount	40-963-026-RF	8
	PCB Connector 26-Pin D-Type, 3 A		Straight PCB Mount	40-963-026-SF	9

Male PCB Connectors



Description		Gender & Cable Exit	Type	Product Order Code and Part Number	Page
	PCB Connector 26-Pin D-Type, 5 A	Male	Right Angle PCB Mount	40-963-026-RM	10
	PCB Connector 26-Pin D-Type, 3 A		Straight PCB Mount	40-963-026-SM	11

Please click on the page number to navigate to the data sheet page required. Return to this page via the **C** button.

Additional Accessories

Although the items below do not directly mate with Pickering Interfaces products, customers may find them useful in the development of their own connection solutions.

Cable Assemblies

Description		End 1	End 2		Cable Length	Product Order Code and Part Number	Data Sheet Page
		Gender & Cable Exit	Gender & Cable Exit	Options			
	Cable Assy, 26-Pin D-Type, 3 A	Male, 45° Towards Pin 1	Male, 45° Towards Pin 1	-	0.5 m 1 m 2 m	40-970-026-0.5m-MM 40-970-026-1m-MM 40-970-026-2m-MM	13
	Cable Assy, 26-Pin D-Type to Unterminated, 3 A	Male, 45° Towards Pin 1	NA	Ferrules	0.5 m 1 m 2 m	40-972-026-0.5m-MU 40-972-026-1m-MU 40-972-026-2m-MU	14
				Tinned End	0.5 m 1 m 2 m	A026HM5-T-0A050 A026HM5-T-0A100 A026HM5-T-0A200	
				Cut End	0.5 m 1 m 2 m	A026HM5-C-0A050 A026HM5-C-0A100 A026HM5-C-0A200	

Note: Custom lengths by quotation

Male Connectors

Description	Gender & Cable Exit	Type	Product Order Code and Part Number	Page
	Male, 45° Options	With Backshell	40-960-026-M	15
		Without Backshell	92-960-026-M	

Custom Termination

Customization Possibilities 16

- High Specification, Highly Flexible Cable
- Fully Screened Cable Construction with Strain Relief
- 45 Degree Cable Exit

Technical Specification

Connector Type (End A):	26-Pin D-Subminiature, High density
Gender	Female
Securing Method	4-40 UNC screwlocks, male
Connector Type (End B):	26-Pin D-Subminiature, High density
Gender	Male
Securing Method	4-40 UNC screwlocks, male
Maximum Current	3 A
Maximum Voltage	250 VAC/400 VDC
Insulation Resistance	1000 MOhm
Connectors:	
Contact Material	Gold plated copper alloy
Contact Resistance	20 mOhm
Cable Exit:	
Female Connectors	45° (Away from Pin 1)
Male Connectors	45° (Towards Pin 1)
Overall Size (Approx)	H40 x W15 x D48 mm
Cable Type:	Individual wires, screened & sleeved
Conductor: Material	Silver plated copper wire
Strands	7/0.15 (0.124 mm ² , 26AWG)
Resistance	0.137 Ω/m
Insulation	PFA
Outer Sleeve	Polyester
Screened Construction	Yes (Cable screen connected to backshells)
Additional Braided Sleeve	Yes
Cable O/D	10 mm
Minimum Bend Radius	25 mm
Door Closure Allowance	48 mm (see diagram)



26-Pin D-Type Cable Assembly

Product Compatibility

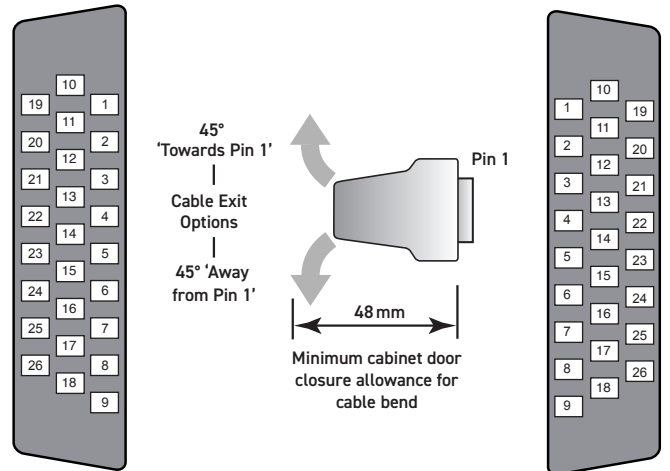
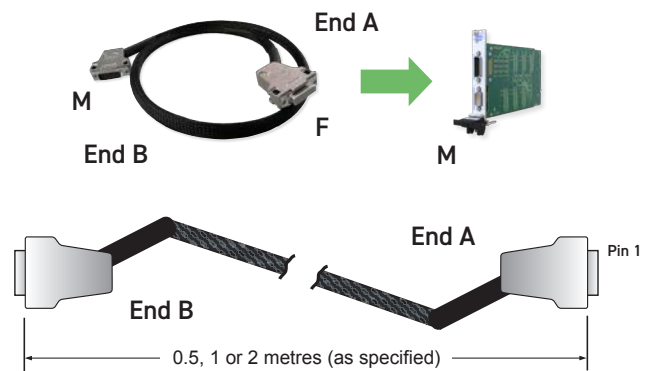

End B - Male Mating Face

End A - Female Mating Face

Product Order Codes

26-Pin D-Type Cable Assy, 3 A, Male to Female,	
0.5 m Long	40-970-026-0.5m-MF
1.0 m Long	40-970-026-1m-MF
2.0 m Long	40-970-026-2m-MF

Note: Other cable lengths can be supplied.

- High Specification, Highly Flexible Cable
- Fully Screened Cable Construction with Strain Relief
- 45 Degree Cable Exit

Technical Specification

Connector Type (End A):	26-Pin D-Subminiature, High density
Gender	Female
Securing Method	4-40 UNC screwlocks, male
Connector Type (End B):	26-Pin D-Subminiature, High density
Gender	Female
Securing Method	4-40 UNC screwlocks, male
Maximum Current	3 A
Maximum Voltage	250 VAC/400 VDC
Insulation Resistance	1000 MOhm
Connectors:	
Contact Material	Gold plated copper alloy
Contact Resistance	20 mOhm
Cable Exit:	45° (Away from Pin 1)
Overall Size (Approx)	H40 x W15 x D48 mm
Cable Type:	Individual wires, screened & sleeved
Conductor: Material	Silver plated copper wire
Strands	7/0.15 (0.124 mm ² , 26AWG)
Resistance	0.137 Ω/m
Insulation	PFA
Outer Sleeve	Polyester
Screened Construction	Yes (Cable screen connected to backshells)
Additional Braided Sleeve	Yes
Cable O/D	10 mm
Minimum Bend Radius	25 mm
Door Closure Allowance	48 mm (see diagram)



26-Pin D-Type Cable Assembly

Product Compatibility

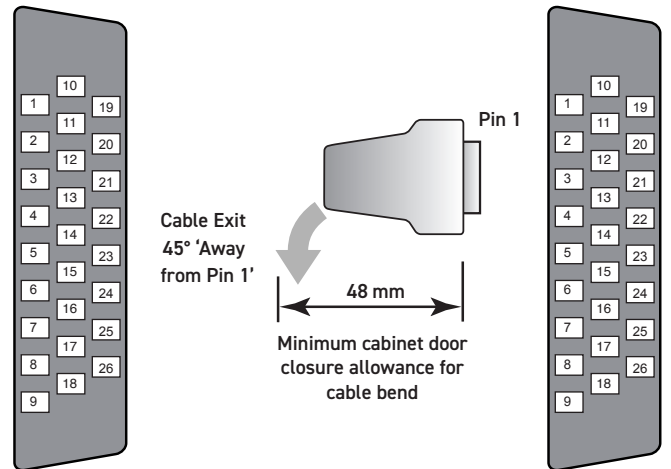
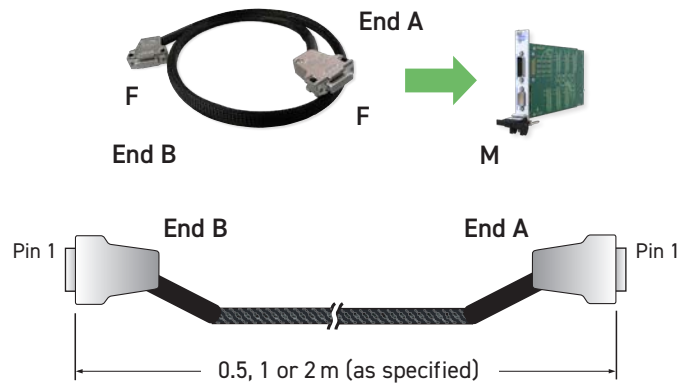

End B - Female Mating Face

End A - Female Mating Face

Product Order Codes

26-Pin D-Type Cable Assy, 3 A, Female to Female,	
0.5 m Long	40-970-026-0.5m-FF
1.0 m Long	40-970-026-1m-FF
2.0 m Long	40-970-026-2m-FF

Note: Other cable lengths can be supplied.

- High Specification, Highly Flexible Cable
- Fully Screened Cable Construction with Strain Relief
- 45 Degree Cable Exit
- Fully Coded Markers to Ensure Easy Connection



26-Pin D-Type Unterminated Cable Assembly

Technical Specification

Connector Type (End A):	26-Pin D-Subminiature, High density
Gender	Female
Securing Method	4-40 UNC screwlocks, male
Unterminated End (End B):	
Free Wire Length	130 mm nominal
Individual Wire Labelling	To connector pins. A white/black screen pigtail is also included
Wire End Options	Ferrules, Tinned, Cut End
Maximum Current	3 A
Maximum Voltage	250 VAC/400 VDC
Insulation Resistance	1000 MOhm
Connector:	
Contact Material	Gold plated copper alloy
Contact Resistance	20 mOhm
Cable Exit	45° (Away from Pin 1)
Overall Size (Approx)	H40 x W15 x D48 mm
Cable Type:	Individual wires, screened & sleeved
Conductor: Material	Silver plated copper wire
Strands	7/0.15 (0.124 mm ² , 26AWG)
Resistance	0.137 Ω/m
Insulation	PFA
Outer Sleeve	Polyester
Screened Construction	Yes (Cable screen connected to backshell)
Additional Braided Sleeve	Yes
Cable O/D	10 mm
Minimum Bend Radius	25 mm
Door Closure Allowance	48 mm (see diagram)

Note: When using this product please ensure appropriate electrical safety.

Product Compatibility

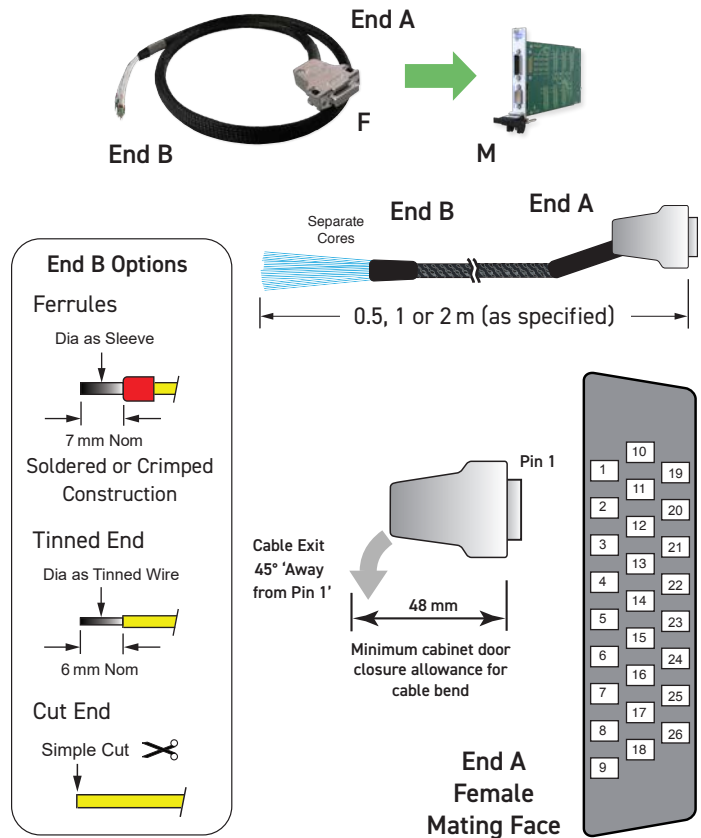

Product Order Codes

26-Pin D-Type Cable Assy, 3 A, Female to Unterminated,
 Ferrules, 0.5 m Long 40-972-026-0.5m-FU
 Ferrules, 1.0 m Long 40-972-026-1m-FU
 Ferrules, 2.0 m Long 40-972-026-2m-FU

Part numbers for other versions:

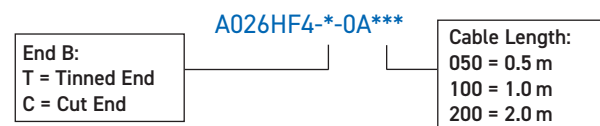

Note: Other cable lengths can be supplied.

- Connector only or Connector and Backshell
- Cable Clamp in Backshell
- Soldered Cable Termination

This accessory is designed to allow users to directly terminate with soldered connections to the connector.

Connector and shell are supplied separately to allow the user to determine the direction of the cable exit.

When the product is used without a backshell users should make their own cable strain relief arrangements and ensure appropriate electrical safety precautions are observed.

Technical Specification

Connector Type:	26-Pin D-Subminiature, High density
Gender	Female
Securing Method:	
Product with Backshell	4-40 UNC screwlocks, male
Product without Backshell	4-40 UNC screwlocks, male
Wire Connection	Solder bucket. A backshell fixing is also provided for a cable screen
Connector Ratings:	
Maximum Current	3 A
Maximum Voltage	250 V AC
Cable Exit:	45°
Cable Exit Size	10 mm dia
Overall Size (Approx)	H40 x W15 x D48 mm
26-Pin D-Sub:	
Contact Material	Gold plated copper alloy
Contact Resistance	20 mOhm
Wire Connection:	
Maximum Wire Size	26AWG
Recommended Insulation	PFA
Additional Cable Clamp	Yes (in backshell)



Connector Dimensions



26-Pin D-Type Cable Connector with Backshell

Product Compatibility

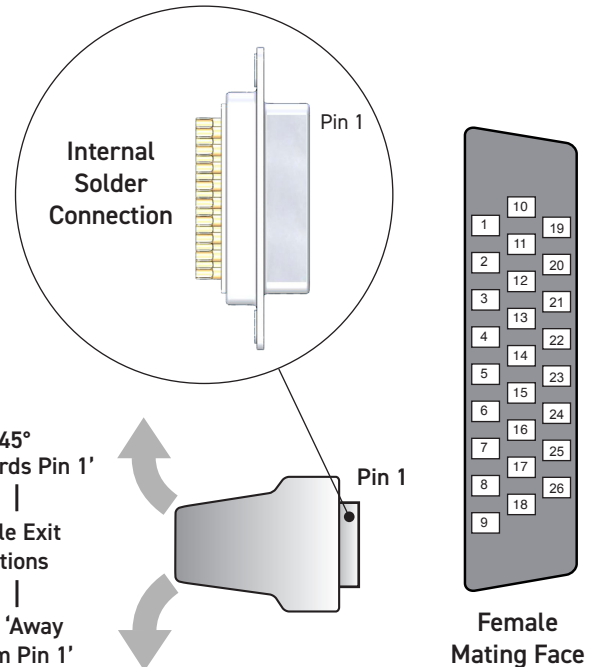

Product Order Codes

26-Pin D-Type Connector, 3 A, Solder Bucket, With Backshell, Female	40-960-026-F
Without Backshell, Female	92-960-026-F

- Right Angle PCB Mount
- Ideal for User Created Termination Solutions

This accessory allows a user to create their own PCB based termination solution mounted on the end of a cable. Suitable cables for this product are contained elsewhere in this data sheet. Interfacing PCBs should be designed with suitable clearances for the voltage the application requires.

Note: This product is not suitable for directly mounting onto the front panel of a Pickering switching product.

Technical Specification

Connector Type:	26-Pin D-Subminiature, High density
Gender	Female
Securing Method	4-40 UNC screwlocks, female
PCB Mounting	Right angle PCB mount, solder
Connector Ratings:	
Maximum Current	5 A each pin
Maximum Voltage	500 V max
26-Pin D-Sub:	
Contact Material	Gold plated copper alloy
Contact Resistance	<20 mOhm
PCB Legs:	
Effective Leg Length	3.6 mm nom (See diagram)

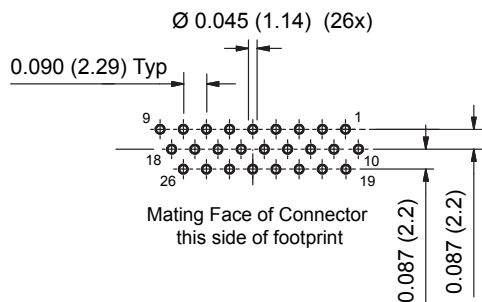

PCB Footprint of 26-Pin Right Angle Female Connector
(Connector Side - Not to Scale)

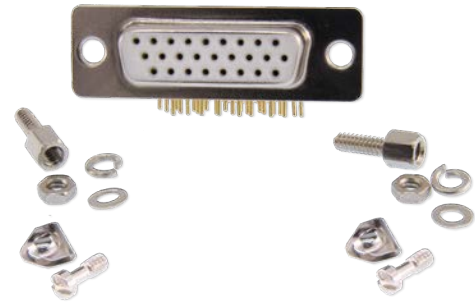

26-Pin D-Type PCB Connector

Product Compatibility

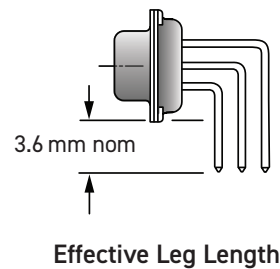

Effective Leg Length

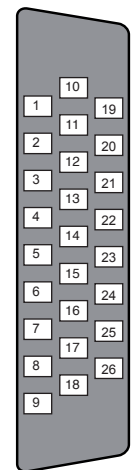

Female Mating Face

Product Order Codes

26-Pin D-Type Connector, 5 A, Right Angle PCB Mount, Female [40-963-026-RF](#)

- Straight PCB Mount
- Ideal for User Created Termination Solutions

This accessory allows a user to create their own PCB based termination solution mounted on the end of a cable. Suitable cables for this product are contained elsewhere in this data sheet. Interfacing PCBs should be designed with suitable clearances for the voltage the application requires.

Note: This product is not suitable for directly mounting onto the front panel of a Pickering switching product.

Technical Specification

Connector Type:	26-Pin D-Subminiature, High density
Gender	Female
Securing Method	4-40 UNC screwlocks, female
PCB Mounting	Straight PCB mount, solder
Connector Ratings:	
Maximum Current	3 A each pin
Maximum Voltage	500 V max
26-Pin D-Sub:	
Contact Material	Gold plated copper alloy
Contact Resistance	<20 mOhm
PCB Legs:	
Leg Length	3.7 mm nom (See diagram)

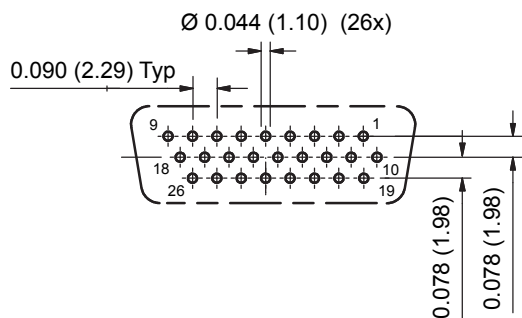

PCB Footprint of 26-Pin Straight Female Connector
(Connector Side - Not to Scale)

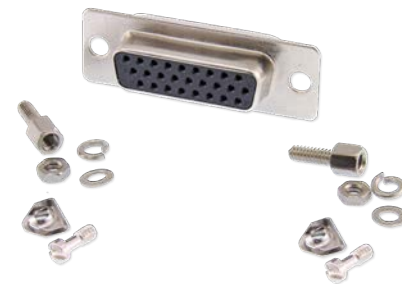

26-Pin D-Type PCB Connector

Product Compatibility

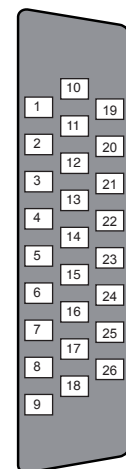
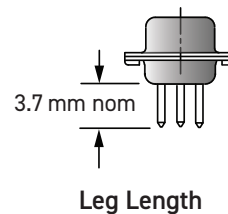

Female Mating Face

Product Order Codes

26-Pin D-Type Connector, 3 A, Straight PCB Mount, Female [40-963-026-SF](#)

- Right Angle PCB Mount
- Ideal for User Created Termination Solutions

This accessory allows a user to create their own PCB based termination solution mounted on the end of a cable. Suitable cables for this product are contained elsewhere in this data sheet. Interfacing PCBs should be designed with suitable clearances for the voltage the application requires.

Note: This product is not suitable for directly mounting onto the front panel of a Pickering switching product.

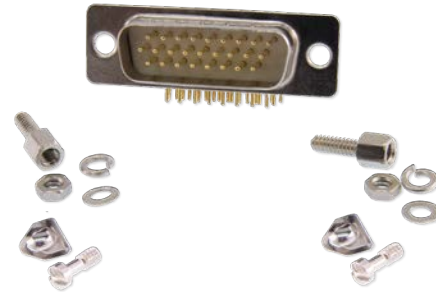

26-Pin D-Type PCB Connector

Product Compatibility



Technical Specification

Connector Type:	26-Pin D-Subminiature, High density
Gender	Male
Securing Method	4-40 UNC screwlocks, female
PCB Mounting	Right angle PCB mount, solder
Connector Ratings:	
Maximum Current	5 A each pin
Maximum Voltage	500 V max
26-Pin D-Sub:	
Contact Material	Gold plated copper alloy
Contact Resistance	<20 mOhm
PCB Legs:	
Effective Leg Length	3.6 mm nom (See diagram)

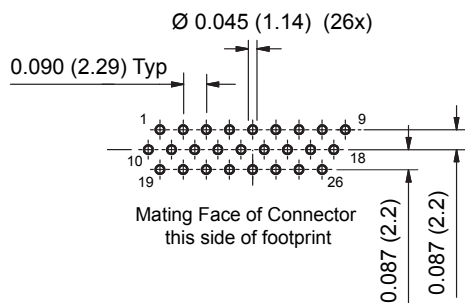

PCB Footprint of 26-Pin Right Angle Male Connector
(Connector Side - Not to Scale)

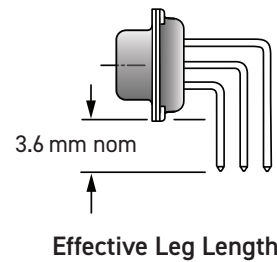

Effective Leg Length

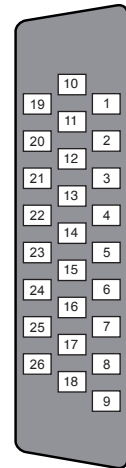

Male Mating Face

Product Order Codes

26-Pin D-Type Connector, 5 A, Right Angle PCB Mount, Male [40-963-026-RM](#)

- Straight PCB Mount
- Ideal for User Created Termination Solutions

This accessory allows a user to create their own PCB based termination solution mounted on the end of a cable. Suitable cables for this product are contained elsewhere in this data sheet. Interfacing PCBs should be designed with suitable clearances for the voltage the application requires.

Note: This product is not suitable for directly mounting onto the front panel of a Pickering switching product.

Technical Specification

Connector Type:	26-Pin D-Subminiature, High density
Gender	Male
Securing Method	4-40 UNC screwlocks, female
PCB Mounting	Straight PCB mount, solder
Connector Ratings:	
Maximum Current	3 A each pin
Maximum Voltage	500 V max
26-Pin D-Sub:	
Contact Material	Gold plated copper alloy
Contact Resistance	<20 mOhm
PCB Legs:	
Leg Length	3.7 mm nom (See diagram)

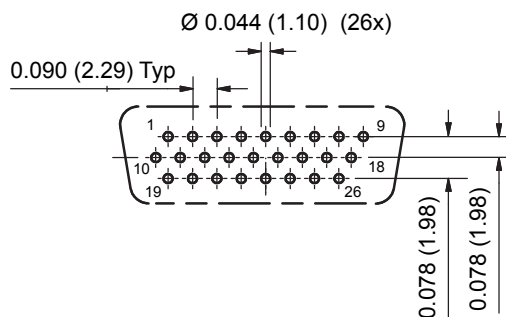

PCB Footprint of 26-Pin Straight Male Connector
(Connector Side - Not to Scale)

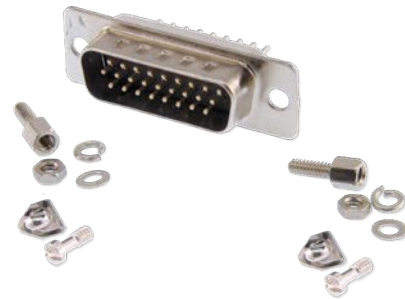

26-Pin D-Type PCB Connector

Product Compatibility

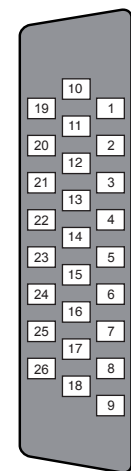
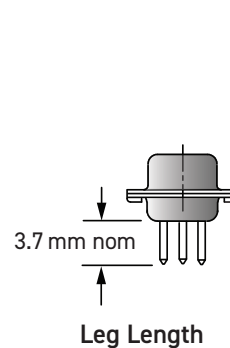

Male Mating Face

Product Order Codes

26-Pin D-Type Connector, 3 A, Straight PCB Mount, Male

[40-963-026-SM](#)

Additional Connection Accessories

Although these items do not directly mate with Pickering Interfaces products customers may find them useful in the development of their own connection solutions.

- High Specification Cable
- Highly Flexible Cable with Braided Sleaving
- Fully Screened Cable Construction with Strain Relief
- 45 Degree Cable Exit

Technical Specification

Connector Type (End A):	26-Pin D-Subminiature, High density
Gender	Male
Securing Method	4-40 UNC screwlocks, male
Connector Type (End B):	26-Pin D-Subminiature, High density
Gender	Male
Securing Method	4-40 UNC screwlocks, male
Maximum Current	3 A
Maximum Voltage	250 VAC/400 VDC
Insulation Resistance	1000 MOhm
Connectors:	
Contact Material	Gold plated copper alloy
Contact Resistance	20 mOhm
Cable Exit	45° (Towards Pin 1)
Overall Size (Approx)	H40 x W15 x D48 mm
Cable Type:	Individual wires, screened & sleeved
Conductor: Material	Silver plated copper wire
Strands	7/0.15 (0.124 mm ² , 26AWG)
Resistance	0.137 Ω/m
Insulation	PFA
Outer Sleeve	Polyester
Screened Construction	Yes (Cable screen connected to backshells)
Additional Braided Sleeve	Yes
Cable O/D	10 mm
Minimum Bend Radius	25 mm
Door Closure Allowance	48 mm (see diagram)

This Cable Assembly is Not Suitable for Connection to a Pickering Switching Product



26-Pin D-Type Cable Assembly

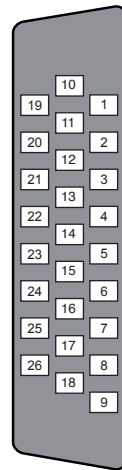
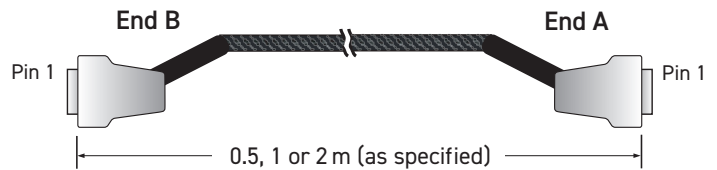

End B - Male Mating Face

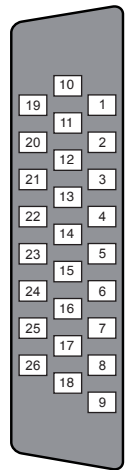
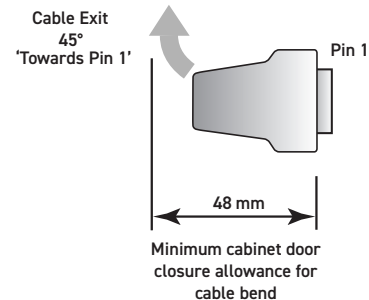

End A - Male Mating Face

Product Order Codes

26-Pin D-Type Cable Assy, 3 A, Male to Male,	
0.5 m Long	40-970-026-0.5m-MM
1.0 m Long	40-970-026-1m-MM
2.0 m Long	40-970-026-2m-MM

Note: Other cable lengths can be supplied.

- High Specification, Highly Flexible Cable
- Fully Screened Cable Construction with Strain Relief
- 45 Degree Cable Exit
- Fully Coded Markers to Ensure Easy Connection

Technical Specification

Connector Type (End A):	26-Pin D-Subminiature, High density
Gender	Male
Securing Method	4-40 UNC screwlocks, male
Unterminated End (End B):	
Free Wire Length	130mm nominal
Individual Wire Labelling	To connector pins. A white/black screen pigtail is included
Wire End Options	Ferrules, Tinned, Cut End
Maximum Current	3 A
Maximum Voltage	250 VAC/400 VDC
Insulation Resistance	1000 MOhm
Connector:	
Contact Material	Gold plated copper alloy
Contact Resistance	20 mOhm
Cable Exit	45° (Towards Pin 1)
Overall Size (Approx)	H40 x W15 x D48 mm
Cable Type:	Individual wires, screened & sleeved
Conductor: Material	Silver plated copper wire
Strands	7/0.15 (0.124 mm ² , 26AWG)
Resistance	0.137 Ω/m
Insulation	PFA
Outer Sleeve	Polyester
Screened Construction	Yes (Cable screen connected to backshell)
Additional Braided Sleeve	Yes
Cable O/D	10 mm
Minimum Bend Radius	25 mm
Door Closure Allowance	48 mm (see diagram)

Note: When using this product please ensure appropriate electrical safety.

This Cable Assembly is Not Suitable for Connection to a Pickering Switching Product



26-Pin D-Type Unterminated Cable Assembly

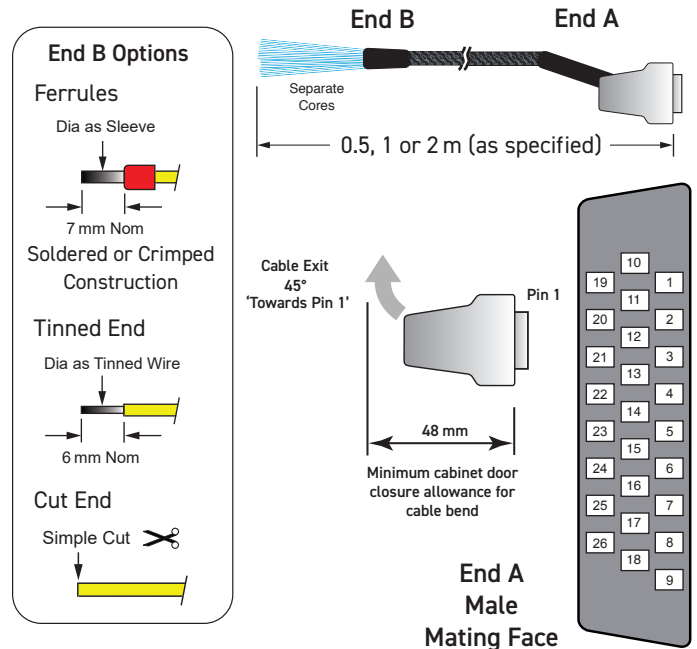

Product Order Codes

26-Pin D-Type Cable Assy, 3 A, Male to Unterminated,
 Ferrules, 0.5 m Long [40-972-026-0.5m-MU](#)
 Ferrules, 1.0 m Long [40-972-026-1m-MU](#)
 Ferrules, 2.0 m Long [40-972-026-2m-MU](#)

Part numbers for other versions:

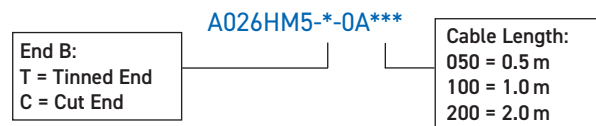

Note: Other cable lengths can be supplied.

- Connector only or Connector and Backshell
- Male Screwlocks
- Cable Clamp in Backshell
- Soldered Cable Termination

This accessory is designed to allow users to directly terminate with soldered connections to the connector.

Connector and shell are supplied separately to allow the user to determine the direction of the cable exit.

When the product is used without a backshell users should make their own cable strain relief arrangements and ensure appropriate electrical safety precautions are observed.

This Connector is Not Suitable for Connection to a Pickering Switching Product

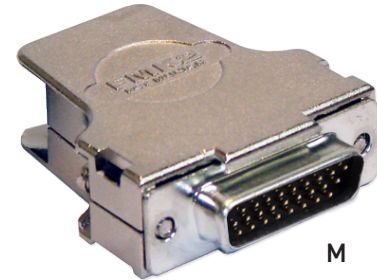

26-Pin D-Type Cable Connector with Backshell

Technical Specification

Connector Type:	26-Pin D-Subminiature, High density
Gender	Male
Securing Method:	
Product with Backshell	4-40 UNC screwlocks, male
Product without Backshell	4-40 UNC screwlocks, male
Wire Connection	Solder bucket. A backshell fixing is also provided for a cable screen
Connector Ratings:	
Maximum Current	3 A
Maximum Voltage	250 V AC
Cable Exit:	45°
Cable Exit Size	10 mm dia
Overall Size (Approx)	H40 x W15 x D48 mm
26-Pin D-Sub:	
Contact Material	Gold plated copper alloy
Contact Resistance	20 mOhm
Wire Connection:	
Maximum Wire Size	26AWG
Recommended Insulation	PFA
Additional Cable Clamp	Yes (in backshell)

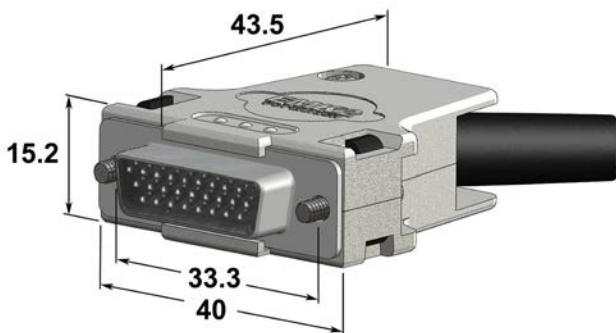
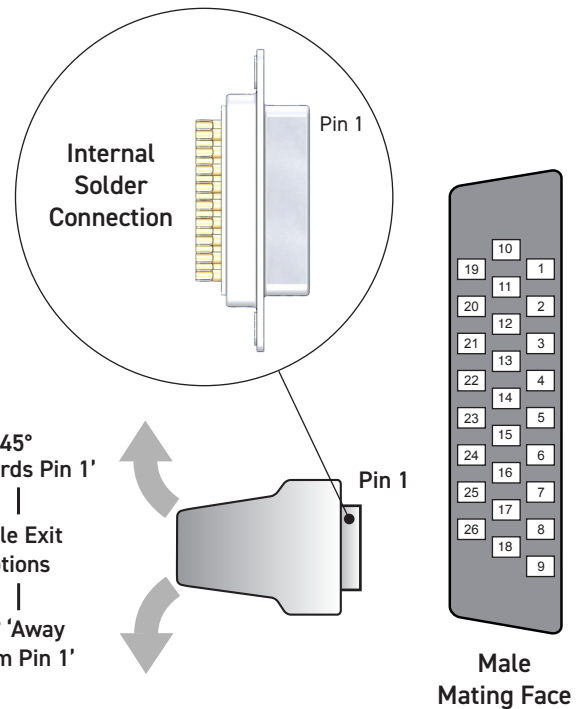

Connector Dimensions

Product Order Codes

26-Pin D-Type Connector, 3 A, Solder Bucket,
 With Backshell, Male [40-960-026-M](#)
 Without Backshell, Male [92-960-026-M](#)

Custom Termination

Pickering Interfaces are able to manufacture custom built cable assemblies and backshells that mate with all the connectors we use in our extensive product range and to provide connection solutions for third party products.

We are able to model and manufacture cable assemblies and other termination arrangements to user notes and drawings, and to deal with simple and complex assemblies, and both small and high volume orders.

All products are designed to ensure easy and problem free connection.

We offer a fast turn round of custom items to keep your ordering and integration time scales to a minimum.



Pickering's Cable Design Tool

Our Cable Design Tool is an online tool that allows you to define a cable assembly to exactly meet your requirements.

- Graphical design of customized cable assemblies
- Built-in library of standard cable sets can be used as the basis for customization, or cables can be defined from scratch
- The ability to store cable assemblies in the Cloud and develop them over time
- Each cable design has a PDF documentation file detailing all the specifications
- Allows detailed design including; connector types, wire type, pin definitions, pin & cable labelling, cable bundling, length selection, sleeving, comments, etc.
- Add your own connectors and wires
- Fully supported on major tablet operating systems

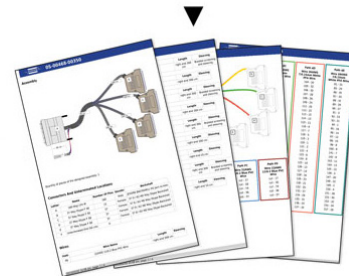
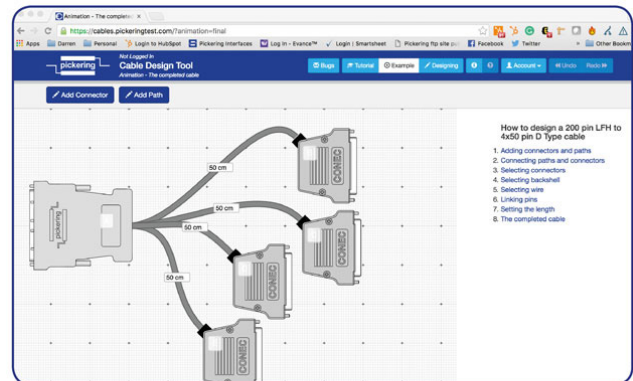

Because the Cable Design Tool is a web-based tool, we will continually update it to better accommodate your requirements and features. Your data is not trapped; complete details of the design are always available to the user at any time via the documentation or spreadsheet file. Once a cable is designed, you can submit it to us for quotation.

For more information visit: pickeringtest.com/cdt