

- Modular Matrix Design with Y Matrix Sizes of 20 or 40
- Loop-Thru Connections for Easy Expansion
- Maximum Switch Current of 2A
- Switch up to 220VDC/125VAC and up to 60W Max Power
- User Configurable for X Dimensions by Plugin addition
- Fully Compliant to 1.4 LXI Standard
- 3 Year Warranty



The 65-219 is a modular matrix platform designed to provide a large matrix solution with 2A current carrying capacity on all Y paths.

Matrices are created by populating the 65-200 chassis with plugin modules with access to the X axis on 15-pin D-type connectors and the Y axis on 50-pin D-type connectors. The chassis is capable of supporting matrices with a Y axis size of 20 or 40 and X axis sizes up to 60 in increments of 10. Users can specify as many or as few plugin modules as they require and can field upgrade the chassis to extend the matrix.

The chassis supports up to 6 plugin modules. These plugins can be X or Y types:

The X type plugins have a 10(X)x40(Y) or 10(X)x20(Y) matrix with connections on a 15-pin D-type plug. Isolation relays are included to minimize capacitance loading and maximize bandwidth. A second 15-pin D-type plug is provided for loop-thru connections.

The Y type plugins have two 50-pin D-type plugs, each providing connection to the Y-Bus via isolation relays. These connections provide access for both Y and Y Loop-thru allowing easy expansion of the system. The chassis can have none of these plugin modules (no direct Y access), 1 or more – the latter providing a simple means of adding Switched Signal connections for additional measurement equipment.

Cooling for the chassis is provided by rear fans and front air intakes ensuring no wasted space when it is rack mounted. The cooling system is adaptive, minimizing acoustic noise when used in quiet laboratory environments. Unused chassis slots are filled using supplied blanking pieces to ensure correct air flow.

Plugins are loaded into the chassis via the front panel, greatly improving the flexibility and ease of maintenance of the unit.

Configuring the Matrix

To select the parts that you need to create a matrix simply:

- Specify a **65-200-001** Modular Matrix Chassis.
- Add **65-219-10x** Y Plugin Modules as required.
- Add **65-219-20x** X1 to X10 Plugin Modules needed to make up the X dimension of the matrix – simply divide the X size by 10 and round up to the next integer to find the number required.

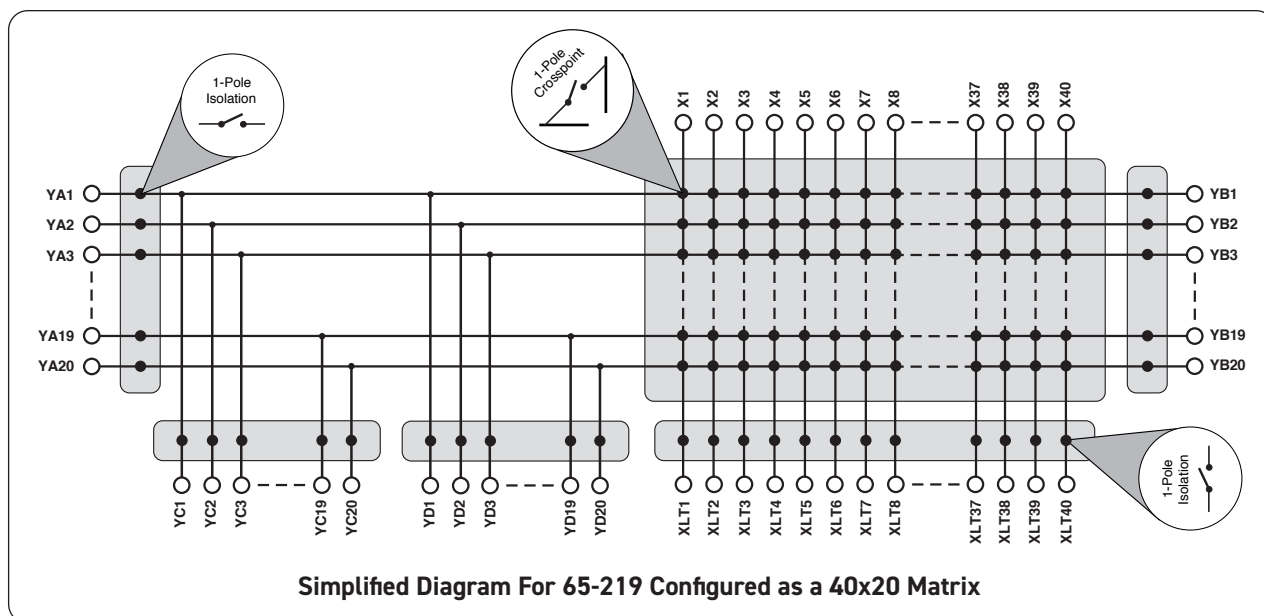

Example Configurations

2U 40x40 Matrix

Matrix that permits 40 concurrent connections to be made between Y and X or 20 between X and X with multiple Y access.

- 1 off 65-200-001 2U Modular Matrix Chassis
- 2 off 65-219-101 Y1 to Y40 Plugin Module
- 4 off 65-219-201 X1 to X10 Plugin Modules

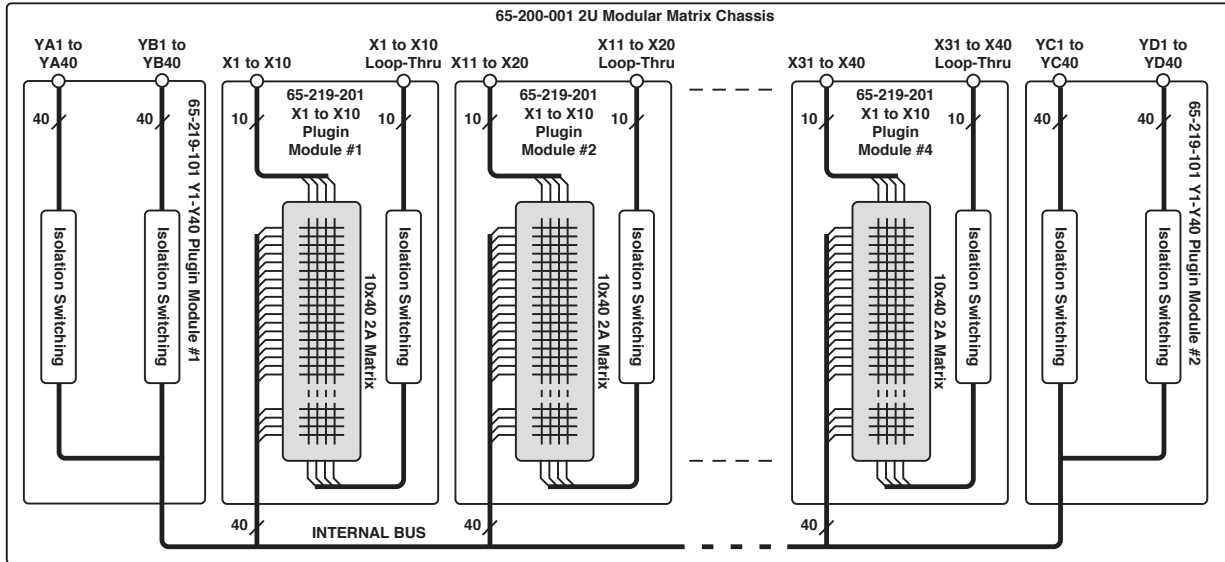

65-219 Configured as a 40x40 matrix with multiple Y connections using a 65-200-001 2U Modular Matrix Chassis, 2 off 65-219-101 Y1 to Y40 Plugin Modules and 4 off 65-219-201 X1 to X10 Plugin Modules

2U 40x20 Matrix

Matrix that permits 20 concurrent connections to be made between Y and X or 20 between X and X with multiple Y access.

- 1 off 65-200-001 2U Modular Matrix Chassis
- 2 off 65-219-102 Y1 to Y20 Plugin Module
- 4 off 65-219-202 X1 to X10 Plugin Modules

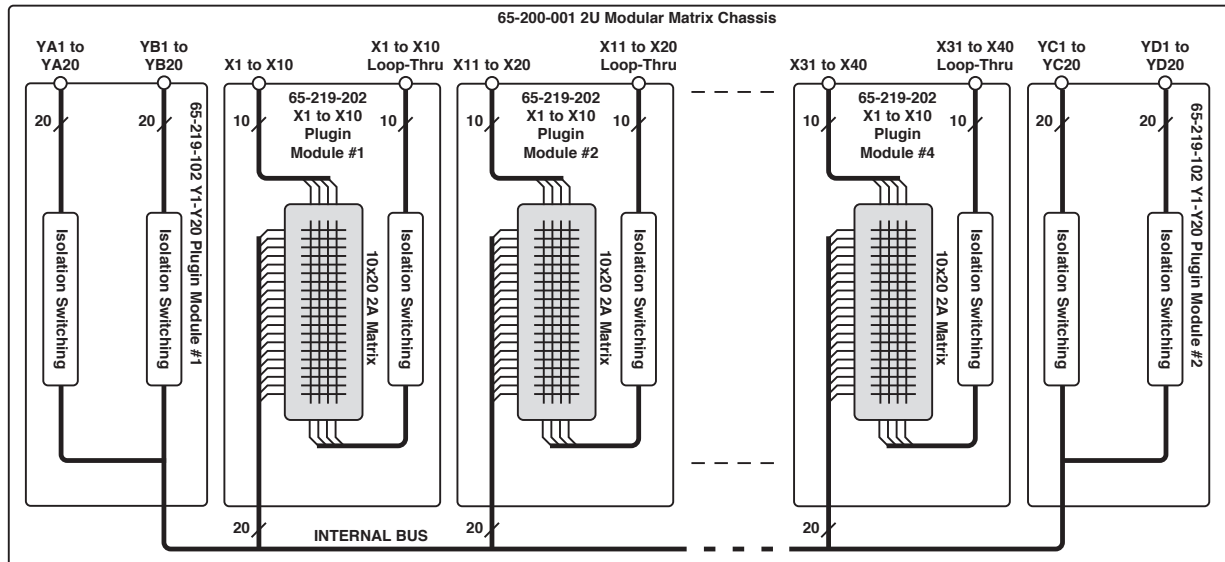

65-219 Configured as a 40x20 matrix with multiple Y connections using a 65-200-001 2U Modular Matrix Chassis, 2 off 65-219-102 Y1 to Y20 Plugin Modules and 4 off 65-219-202 X1 to X10 Plugin Modules

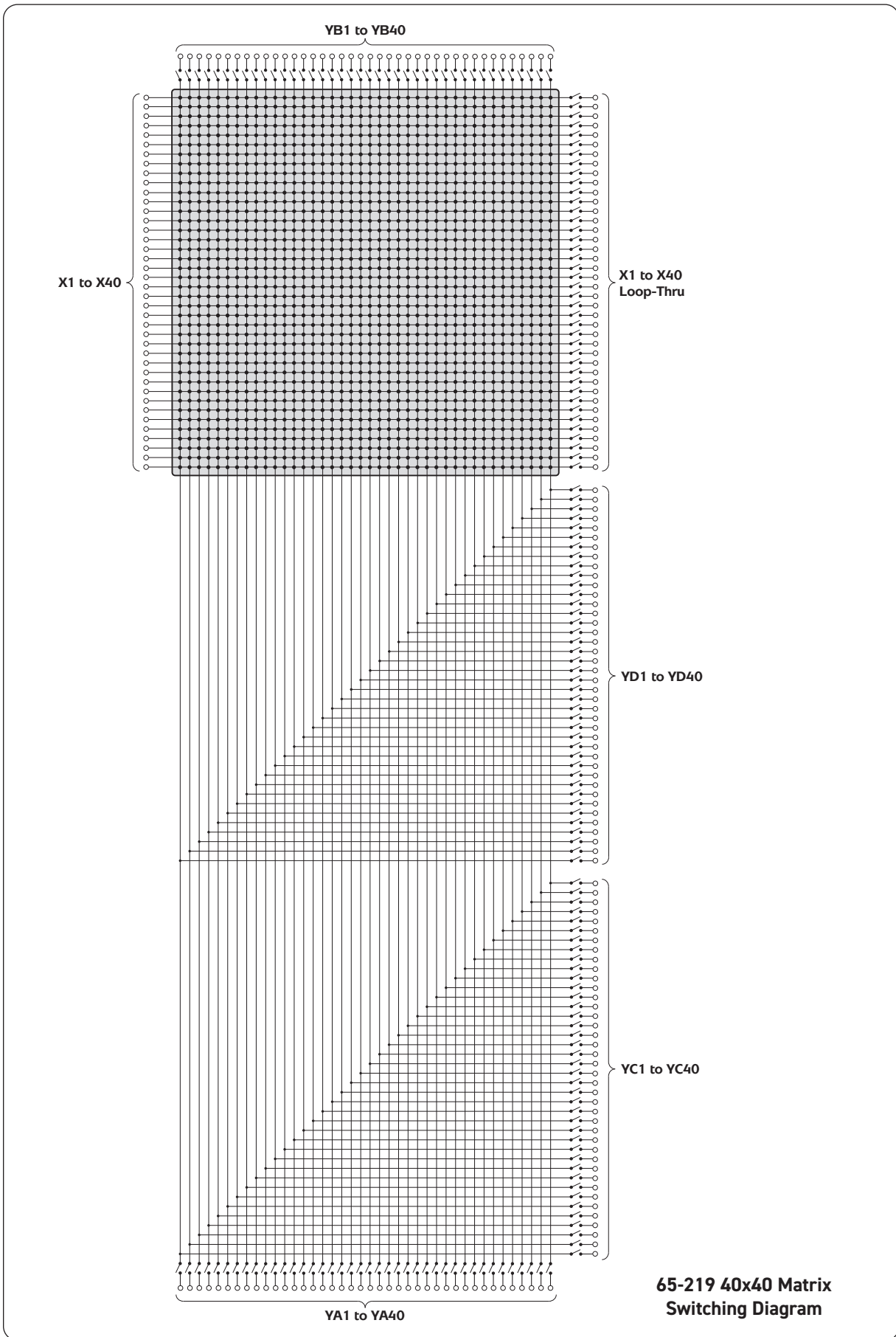

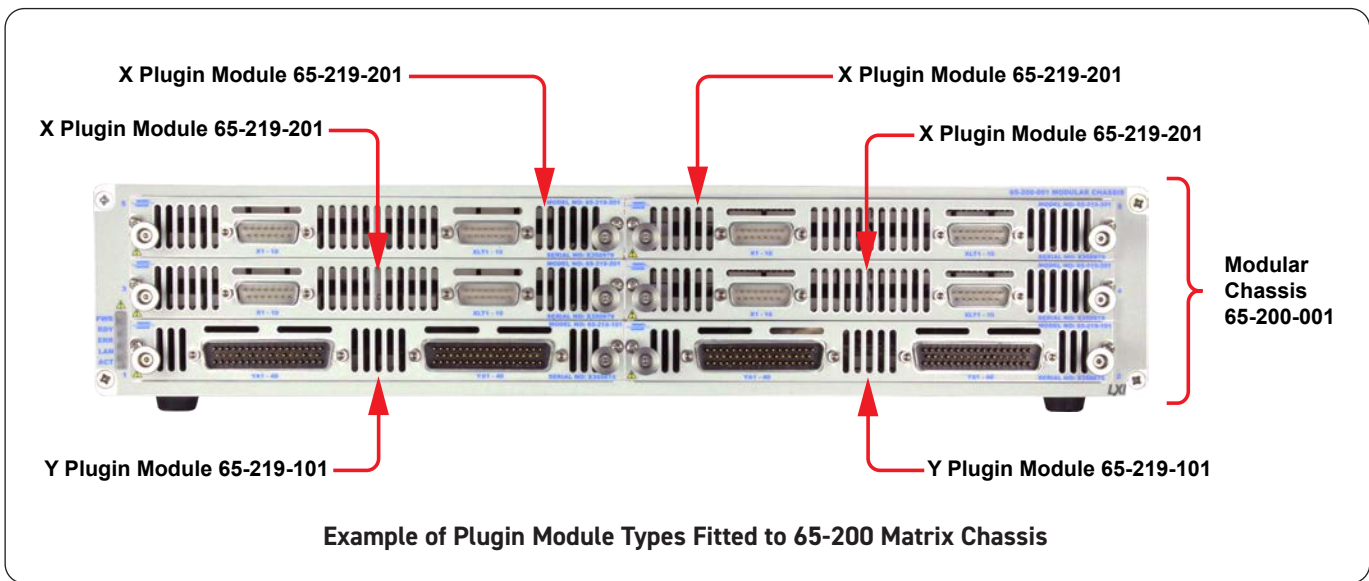

Matrix Switching Specification

General:	Provides 20 or 40 concurrent X to Y or 20 X to X connections
Maximum Size:	60x40 using 65-200-001 (no Y access)
Maximum Switch Current:	2A
Maximum Switch Voltage:	220VDC/125AC*
Maximum Power:	60W/62.5VA
Relay Type:	Electromechanical (Au clad AgNi type)
Plugin Setting Time:	4ms (per relay operation)
Initial Path Resistance:	X Plugin (X to XLT): <0.1Ω Y Plugin (YA to YB): <0.2Ω System (X to Y)†: <1Ω System (X to Y)†: 0.75Ω (typical)
Expected Life (operations):	>1x10 ⁸ (Low Load) >1x10 ⁵ (Full Load)

* For full voltage rating, signal sources to be switched must be fully isolated from mains supply and safety earth.

† This represents an example system configured as a 40x40 matrix consisting of 2x 65-219-101 Y Plugins and 4x 65-219-201 X Plugins housed within a 65-200-001 Chassis.

Power Source

Universal AC mains supply, 90-120/200-240V 50-60Hz.

Power Inlet: Male IEC connector
Power Rating: 100VA maximum
Fuse Rating: (F) 5A 250V

LAN Interface

1000Base-T Ethernet Interface with a standard RJ-45 connector mounted on the rear panel. Compliant to LXI Standard 1.4.

Mechanical Specification

Chassis Dimensions:	2U rack mountable full width, depth 500mm
Number of Plugins Supported:	6 (any combination of X and Y)
X Plugin Connectors:	15-pin male D-type
Y Plugin Connectors:	50-pin male D-type
Chassis Cooling:	Front air intakes through plugin module holes, temperature controlled speed adjustable fans

Operating/Storage Conditions

Operating Conditions (operating with specified airflow)

Operating Temperature: 0°C to +55°C
Humidity: 10% to 90% non-condensing

Storage and Transport Conditions

Storage Temperature: -20°C to +70°C
Humidity: 10% to 90% non-condensing

Safety, CE & RoHS Compliance

All products are fully CE compliant and meet applicable EU directives: Low-voltage safety EN61010-1:2010, EMC Immunity EN61326-1:2013, Emissions EN55011:2009+A1:2010.

The 65-200 Chassis also complies with the European Restriction of Hazardous Substances directive (RoHS).

Matrix RF Specification

Using 65-219-201 & 65-219-202 Plugin Modules

Bandwidth (-3dB):	(Measurement at front panel with no cables connected to loop-thru ports) X Plugin (X to XLT): 12MHz Y Plugin (YA to YB): 6MHz System (X to Y)†: 4MHz
Crosstalk - X Plugin (X to XLT):	<-90dB at 10kHz -70dB at 100kHz -50dB at 1MHz -35dB at 10MHz
Crosstalk - Y Plugin (YA to YB):	-70dB at 10kHz -50dB at 100kHz -30dB at 1MHz -30dB at 10MHz
Crosstalk - System (X to Y)†:	-80dB at 10kHz -60dB at 100kHz -35dB at 1MHz -15dB at 10MHz
Isolation - X Plugin (X to XLT):	>90dB at 10kHz 80dB at 100kHz 60dB at 1MHz 45dB at 10MHz
Isolation - Y Plugin (YA to YB):	85dB at 10kHz 65dB at 100kHz 45dB at 1MHz 25dB at 10MHz
Isolation - System (X to Y)†:	>90dB at 10kHz >90dB at 100kHz >90dB at 1MHz 50dB at 10MHz

† This represents an example system configured as a 40x40 matrix consisting of 2x 65-219-101 Y Plugins and 4x 65-219-201 X Plugins housed within a 65-200-001 Chassis.

Matrix RF Specification

Using 65-219-203 to 65-219-210 Plugin Modules

Bandwidth (-3dB):	(Measurement at front panel with no cables connected to loop-thru ports) X Plugin (X to XLT): 7MHz Y Plugin (YA to YB): 6MHz System (X to Y)†: 4MHz
Crosstalk - X Plugin (X to XLT):	-50dB at 10kHz -45dB at 100kHz -35dB at 1MHz -15dB at 10MHz
Crosstalk - Y Plugin (YA to YB):	-70dB at 10kHz -50dB at 100kHz -30dB at 1MHz -20dB at 10MHz
Crosstalk - System (X to Y)†:	-65dB at 10kHz -50dB at 100kHz -30dB at 1MHz -15dB at 10MHz
Isolation - X Plugin (X to XLT):	50dB at 10kHz 45dB at 100kHz 35dB at 1MHz 15dB at 10MHz
Isolation - Y Plugin (YA to YB):	85dB at 10kHz 65dB at 100kHz 45dB at 1MHz 25dB at 10MHz
Isolation - System (X to Y)†:	60dB at 10kHz 55dB at 100kHz 35dB at 1MHz 15dB at 10MHz

† This represents an example system configured as 50x40 matrix consisting of 1x 65-219-101 Y Plugin and 5x 65-219-210 X Plugins housed within a 65-200-001 Chassis.

Product Order Codes

Specify which modules are required to build the matrix, Pickering Interfaces will supply the chassis with the modules installed if ordered at the same time. Plug-in modules can be ordered for chassis already supplied.

Chassis

2U Modular Matrix Chassis, 6-Slot **65-200-001**

x40 Configurations

Y1 to Y40 Plugin Y Module **65-219-101**

10(X) x 40(Y) Plugin X Module **65-219-201**

x20 Configurations

Y1 to Y20 Plugin Y Module **65-219-102**

10(X) x 20(Y) Plugin X Module **65-219-202**

x5 to x40 Configurations

10(X) x 5(Y) Plugin X Module **65-219-203**

10(X) x 10(Y) Plugin X Module **65-219-204**

10(X) x 15(Y) Plugin X Module **65-219-205**

10(X) x 20(Y) Plugin X Module **65-219-206**

10(X) x 25(Y) Plugin X Module **65-219-207**

10(X) x 30(Y) Plugin X Module **65-219-208**

10(X) x 35(Y) Plugin X Module **65-219-209**

10(X) x 40(Y) Plugin X Module **65-219-210**

Product Customization

Pickering LXI units are designed and manufactured on our own flexible manufacturing lines, giving complete product control and enabling simple customization to meet very specific requirements.

Customization can include:

- Alternative relay types
- Mixture of relay types
- Alternative number of relays
- Different performance specifications

All customized products are given a unique part number, fully documented and may be ordered at any time in the future. Please contact your local sales office to discuss.

Support Products

Mating Connectors & Cabling

For connection accessories for the 65-219 range of modules please refer to the [90-005D](#) 50-pin D-type and [90-010D](#) 15-pin D-type data sheets where a complete list and documentation can be found for accessories, or refer to the Connection Solutions catalog.



The 65-200 range is part of a growing family of Scalable Matrix systems available from Pickering Interfaces. Illustrated is the LXI 65-110 200MHz RF Matrix, available in sizes up to 104x16



Also available from Pickering are the 60-102B and 60-103B LXI Modular Chassis. These are 7 and 18 slot chassis capable of hosting any of our range of PXI switching and programmable resistor modules under LXI control via a Gigabit Ethernet interface

Connectivity Solutions

We provide a full range of supporting cable and connector solutions for all our switching products—20 connector families with 1200+ products. We offer everything from simple mating connectors to complex cables assemblies and terminal blocks. All assemblies are manufactured by Pickering and are guaranteed to mechanically and electrically mate to our modules.



Connectors & Backshells



Multiwire Cable Assemblies

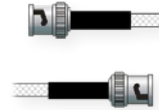

RF Cable Assemblies



Connector Blocks

We also offer customized cabling and have a free online **Cable Design Tool** that can be used to create custom cable solutions for many applications.

Visit: pickeringtest.com/cdt to start your design.

Mass Interconnect

We recommend the use of a mass interconnect solution when an Interchangeable Test Adapter (ITA) is required for a PXI or LXI based test system. Our modules are fully supported by both Virginia Panel and MacPanel.

Pickering Reed Relays

We are the only switch provider with in-house reed relay manufacturing capability via our sister company, Pickering Electronics. These instrument grade reed relays feature **SoftCenter®** technology, ensuring long service life and repeatable contact performance.

To learn more, please go to: pickeringrelay.com

Programming

All LXI devices are supplied with built-in software drivers, web pages for configuration and soft front panels as required by the LXI specification. A variety of drivers are provided (C, .NET, IVI, SOAP) which are compatible with all Microsoft supported versions of Windows and popular older versions. For a list of all supporting operating systems, please see: pickeringtest.com/os

The drivers may be used in many commonly used programming environments and applications including:

- **Pickering Interfaces Switch Path Manager**
- **National Instruments** products (LabVIEW, LabWindows/CVI, Switch Executive, MAX, TestStand, VeriStand, etc.)
- **Microsoft Visual Studio** products (Visual Basic, Visual C++, Visual C#)
- **Keysight** VEE and OpenTAP
- **Mathworks** Matlab
- **Marvin** ATEasy
- **MTQ Testsolutions** Tecap Test & Measurement Suite

As well as various open source environments such as:

- **Sharp Develop**
- **Dev-C++**

To learn more about software drivers and development environments, please go to: pickeringtest.com/software



Signal Routing Software

Our signal routing software, Switch Path Manager, automatically selects and energizes switch paths through Pickering switching systems. Signal routing is performed by simply defining test system endpoints to be connected together, greatly accelerating Test System software development.

To learn more, please go to: pickeringtest.com/spm



Diagnostic Relay Test Tools

eBIRST Switching System Test Tools are designed specifically for our PXI, PCI or LXI products, these tools simplify switching system fault-finding by quickly testing the system and graphically identifying the faulty relay.

To learn more, please go to: pickeringtest.com/ebirst



Three Year Warranty

All standard products manufactured by Pickering Interfaces are warranted against defective materials and workmanship for a period of three years from the date of delivery to the original purchaser. Extended warranty and service agreements are available for all our modules and systems with various levels to suit your requirements. Although we offer a 3-year warranty as standard, we also include guaranteed long-term support—with a history of supporting our products for typically 15-20 years. To learn more, please go to: pickeringtest.com/support

Available Product Resources

We have a large library of product resources including success stories, product and support videos, articles, as well as complete product catalogs and product reference maps to assist when looking for the switching, simulation and cable and connector solutions you need. We have also published handy reference books on Switching Technology and for the PXI and LXI standards.

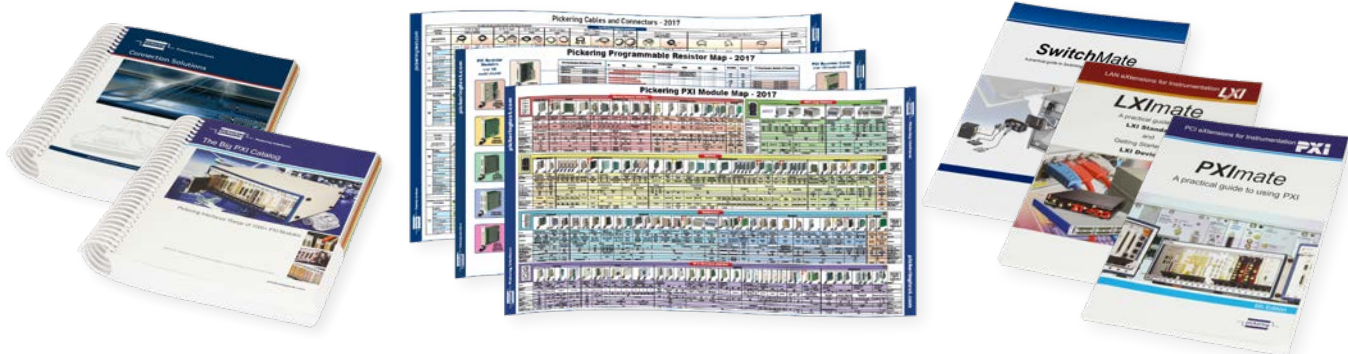

To view, download or request any of our product resources, please visit: pickeringtest.com/resources

© Copyright (2020) Pickering Interfaces. All Rights Reserved
Pickering Interfaces maintains a commitment to continuous product development, consequently we reserve the right to vary from the description given in this data sheet.