



- High Performance 6-Channel RF Multiplexers
- 18 GHz, 26.5 GHz, 40 GHz, 50 GHz & 67 GHz Bandwidth
- Unterminated Versions With up to 16 Multiplexer Banks
- Terminated versions with up to 14 Multiplexer Banks
- 50  $\Omega$  Characteristic Impedance
- Low Loss, High Isolation
- LXI Standard 1.4 Compliant
- IVI & Direct I/O Drivers
- 3 Year Warranty

The 60-800 Microwave Multiplexer is suitable for switching 50  $\Omega$  signals up to 67 GHz. With up to 16 banks of 6 channels it is ideal for constructing complex microwave switching systems for many applications. Connection is by front panel SMA, SMA-2.9, SMA-2.4 or SMA-1.85 connectors.

It is also available in a terminated version with up to 14 banks of 6 channel multiplexers. This version automatically terminates signal channels into 50  $\Omega$  when not connected to the common terminal.

The multiplexer has an extremely high level of performance with low VSWR, very high isolation, low loss and high power handling. It is ideal for switching 50  $\Omega$  systems for HF up to microwave frequencies. It occupies 2U or 3U of rack space, providing a compact switching solution. Multiplexers can be user connected to create customized switching systems which include multiplexers and matrices.

## Controlling the Multiplexer

The 60-800 is controlled through an LXI interface based on 1000Base-T Ethernet. This provides a quick and easy method of installing the 60-800 and a simple way of controlling it at a remote location through its API or built in soft front panel. The ability to control the unit at a distance aids the testing of systems without the need for a physical presence.

## Easy Repair

To allow fast in field repair, relays may be individually replaced without removing the covers from the chassis or the chassis from the host rack.

## Other Microwave Switching Configurations

We are able to offer other microwave switching solutions, if you have a custom requirement for switching please contact your local Pickering Interfaces sales representative

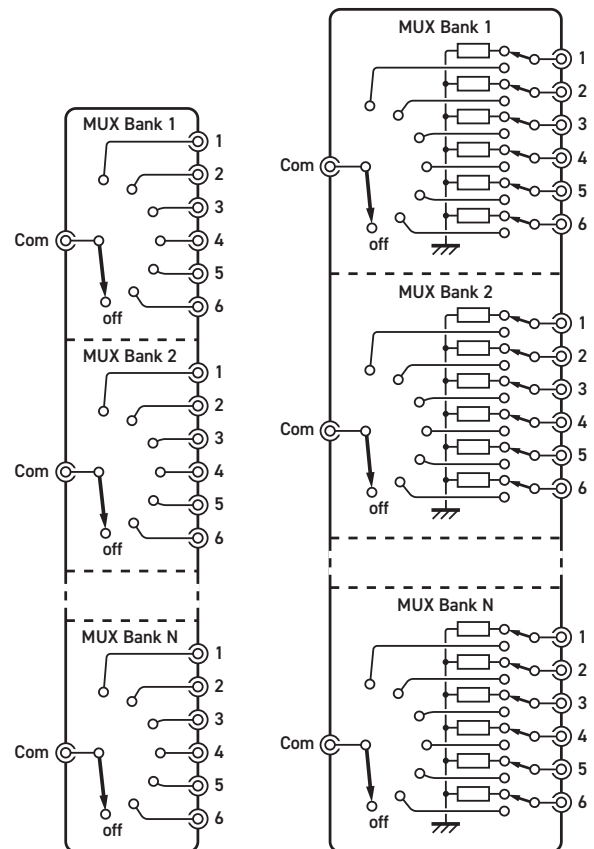

**60-800 Unterminated Microwave MUX - up to 16 Multiplexers can be supported**

**60-800 Terminated Microwave MUX - up to 14 Multiplexers can be supported**

## General Multiplexer Information

Configuration:	6 to 1 Microwave Multiplexer with up to 16 independent banks.
Operating Time:	<18 ms
Maximum Voltage:	100 VDC
Max. Switch Current:	1A

## Power Source

Universal AC mains supply, 90-120/200-240 V 50-60 Hz	
Power Inlet:	Male IEC connector
Power Rating:	100 VA maximum
Fuse Rating:	5 A, 250 V

## LAN Interface

Compliant to LXI Standard 1.4, the 60-800 has a 1000Base-T Ethernet Interface via a standard RJ-45 connector mounted on the rear panel with an LCD display showing the unit's IP address\*.

\*Note: Legacy units may not have 1000Base-T support or be fitted with an LCD display.

## LXI Status Indicators

Front panel mounted LEDs:

- Power
- Ready
- Error
- LAN
- Active

## Mechanical Characteristics

Supplied with front panel ears to enable rack mounting on a shelf or other rear support mechanism.

- Unterminated (18 GHz only) relays, 2U high, full 19" rack width, 500 mm deep.
- Unterminated (50 GHz & 67 GHz) relays (1-8 off), 2U high, full 19" rack width, 500 mm deep.
- Unterminated (50 GHz & 67 GHz) relays (9-16 off), 3U high, full 19" rack width, 500 mm deep.
- Terminated relays (1-7 off), 2U high, full 19" rack width, 500 mm deep.
- Terminated relays (8-14 off), 3U high, full 19" rack width, 500 mm deep.

3D models for all versions in a variety of popular file formats are available on request.

## Connectors

Signals via front panel mounted coaxial connectors:

- 18 GHz, versions - SMA
- 26.5 GHz, versions - SMA
- 40 GHz, versions - SMA-2.9
- 50 GHz, versions - SMA-2.4
- 67 GHz, versions - SMA-1.85

## Cooling

Fan assisted cooling, side air intakes and rear exhaust.

## Operating/Storage Conditions

Operating Temperature:	0 °C to +55 °C
Humidity:	Up to 90% non-condensing
Altitude:	5000 m
Storage/Transport Temperature:	-20 °C to +75 °C
Humidity:	Up to 90% non-condensing
Altitude:	15000 m

## Safety & CE Compliance

All products are fully CE compliant and meet applicable EU directives:

Low-voltage safety EN61010-1:2010,  
EMC Immunity EN61326-1:2013,  
Emissions EN55011:2009+A1:2010.

## Specification - 18 GHz Underterminated & Terminated Versions

Characteristic Impedance:	50 $\Omega$
Connectors:	SMA
Bandwidth	DC to 18 GHz
Isolation:	80 dB (0-3 GHz) 70 dB (3-8 GHz) 60 dB (8-12.4 GHz) 60 dB (12.4-18 GHz)
Insertion Loss:	0.2 dB (0-3 GHz) 0.3 dB (3-8 GHz) 0.4 dB (8-12.4 GHz) 0.5 dB (12.4-18 GHz)
VSWR:	1.2:1 (0-3 GHz) 1.3:1 (3-8 GHz) 1.4:1 (8-12.4 GHz) 1.5:1 (12.4-18 GHz)
Maximum RF Carry Power:	240 W (0-3 GHz) 150 W (3-8 GHz) 120 W (8-12.4 GHz) 100 W (12.4-18 GHz)
Termination Power Rating:	1W per termination, 3W total per 6 channel multiplexer
Expected Life (Low Power):	18 GHz option >5 million operations 18 GHz terminated option >2 million operations

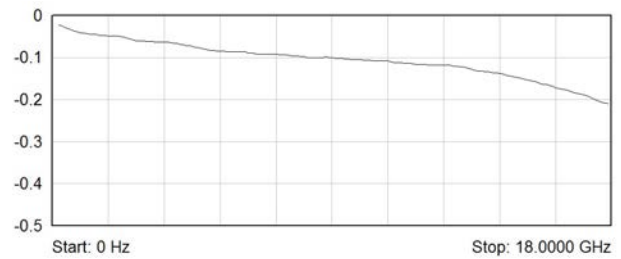

Typical Insertion Loss (dB) Plot for 18 GHz Underterminated Versions

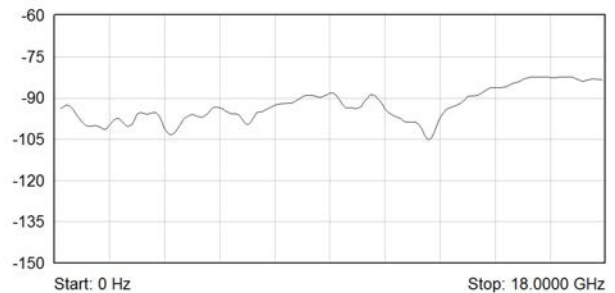

Typical Isolation (dB) Plot for 18 GHz Underterminated Versions

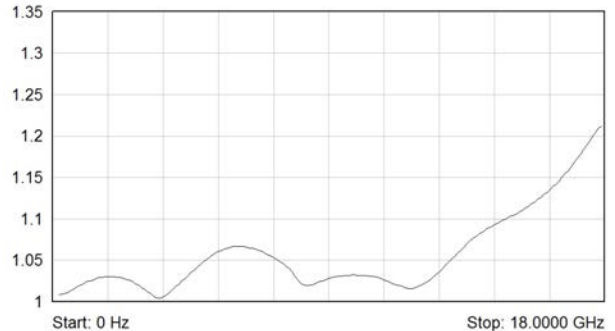

Typical VSWR Plot for 18 GHz Underterminated Versions

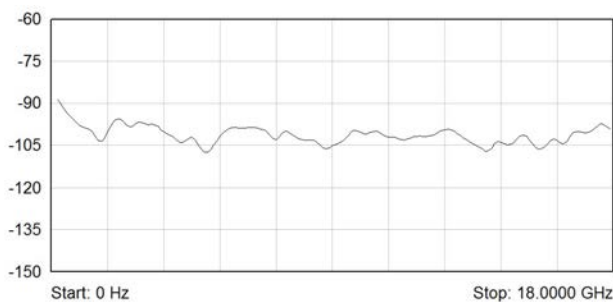

Typical Isolation (dB) Plot for 18 GHz Terminated Versions

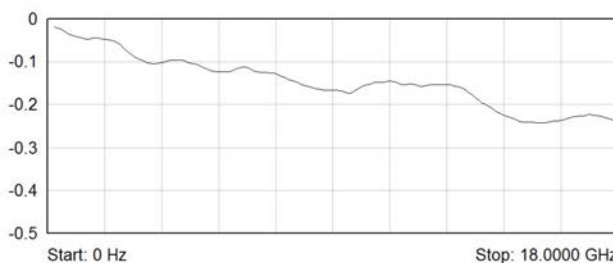

Typical Insertion Loss (dB) Plot for 18 GHz Terminated Versions

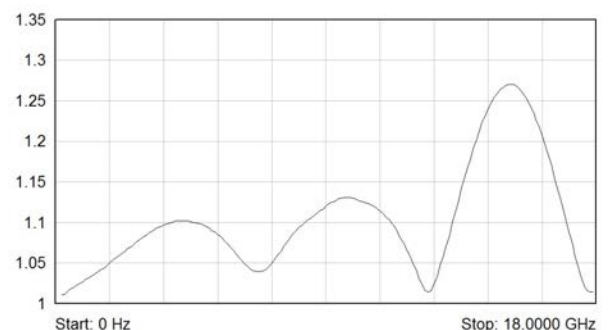

Typical VSWR Plot for 18 GHz Terminated Versions

## Specification - 26.5 GHz Terminated Versions

Characteristic Impedance:	50 $\Omega$
Connectors:	SMA
Bandwidth	DC to 26.5 GHz
Isolation:	80 dB (0-3 GHz) 70 dB (3-8 GHz) 60 dB (8-12.4 GHz) 60 dB (12.4-18 GHz) 55 dB (18-26.5 GHz)
Insertion Loss:	0.2 dB (0-3 GHz) 0.3 dB (3-8 GHz) 0.4 dB (8-12.4 GHz) 0.5 dB (12.4-18 GHz) 0.7 dB (18-26.5 GHz)
VSWR:	1.2:1 (0-3 GHz) 1.3:1 (3-8 GHz) 1.4:1 (8-12.4 GHz) 1.5:1 (12.4-18 GHz) 1.7:1 (18-26.5 GHz)
Maximum RF Carry Power:	240 W (0-3 GHz) 150 W (3-8 GHz) 120 W (8-12.4 GHz) 100 W (12.4-18 GHz) 40 W (18-26.5 GHz)
Termination power rating:	1W per termination, 3 W total per 6 channel multiplexer
Expected Life (low power):	>2 million ops per position

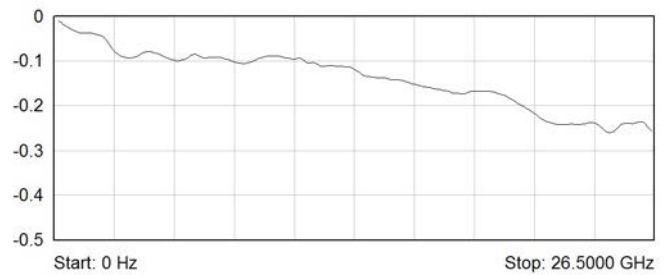

Typical Insertion (dB) Loss Plot for 26.5 GHz Terminated Versions

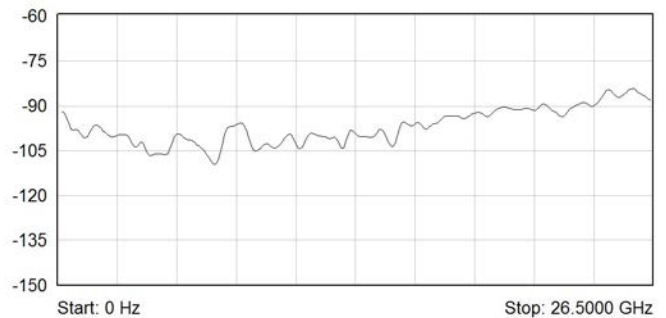

Typical Isolation (dB) Plot for 26.5 GHz Terminated Versions

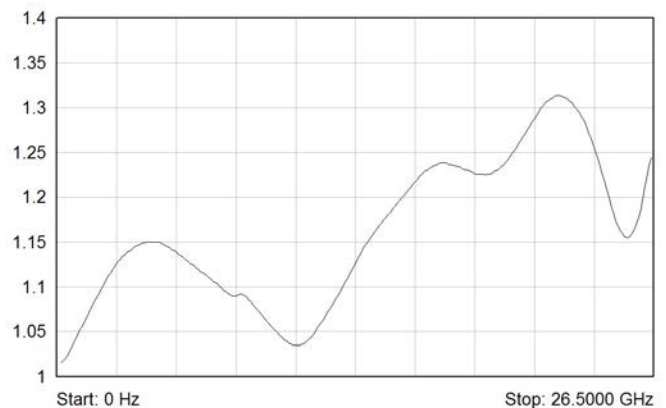

Typical VSWR Plot for 26.5 GHz Terminated Versions

## Specification - 40 GHz Underterminated & Terminated Versions

Characteristic Impedance:	50 $\Omega$
Connectors:	SMA-2.9
Bandwidth	DC to 40 GHz
Isolation:	70 dB (0-6 GHz) 60 dB (6-12.4 GHz) 60 dB (12.4-18 GHz) 55 dB (18-26.5 GHz) 50 dB (26.5-40 GHz)
Insertion Loss:	0.2 dB (0-6 GHz) 0.4 dB (6-12.4 GHz) 0.5 dB (12.4-18 GHz) 0.7 dB (18-26.5 GHz) 1.1 dB (26.5-40 GHz)
VSWR:	1.3:1 (0-6 GHz) 1.4:1 (6-12.4 GHz) 1.5:1 (12.4-18 GHz) 1.7:1 (18-26.5 GHz) 2.2:1 (26.5-40 GHz)
Maximum RF Carry Power:	40 W (0-6 GHz) 30 W (6-12.4 GHz) 25 W (12.4-18 GHz) 15 W (18-26.5 GHz) 5 W (26.5-40 GHz)
Termination power rating:	1W per termination, 3 W total per 6 channel mux
Expected Life (Low Power):	>2 million ops per position

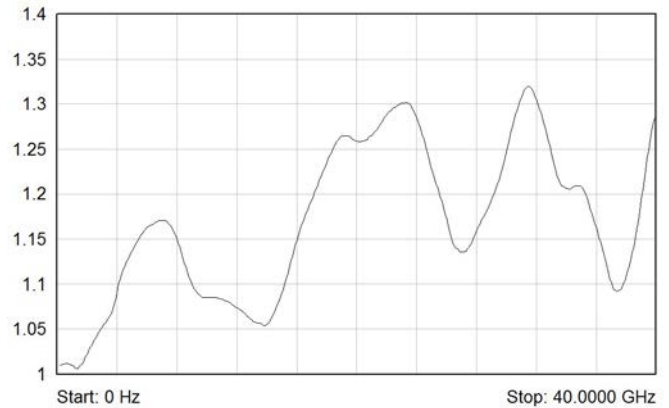

Typical VSWR Plot for 40 GHz Underterminated Versions

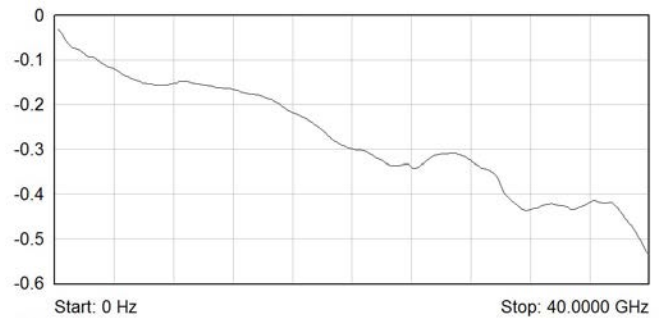

Typical Insertion Loss (dB) Plot for 40 GHz Underterminated Versions

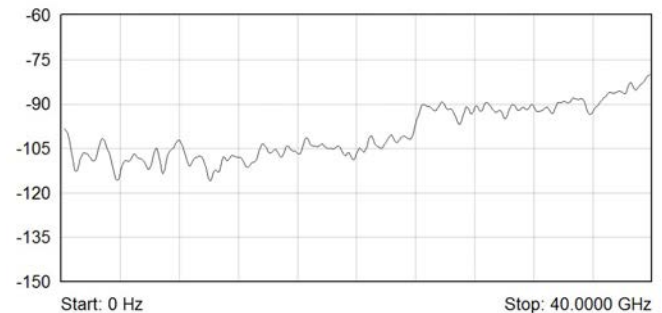

Typical Isolation (dB) Plot for 40 GHz Underterminated Versions

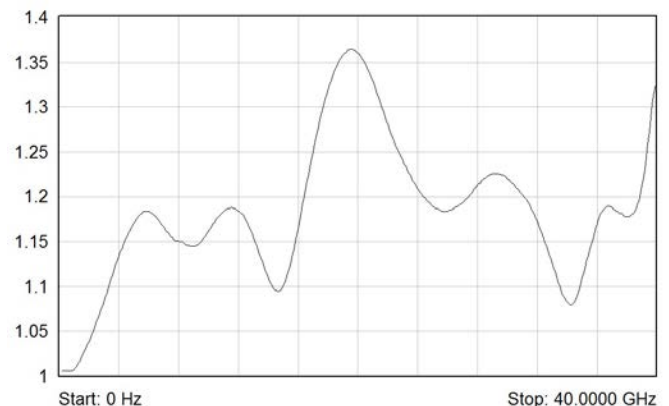

Typical VSWR Plot for 40 GHz Terminated Versions

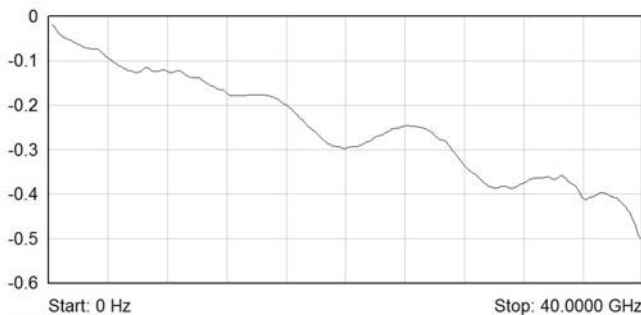

Typical Insertion (dB) Loss Plot for 40 GHz Terminated Versions

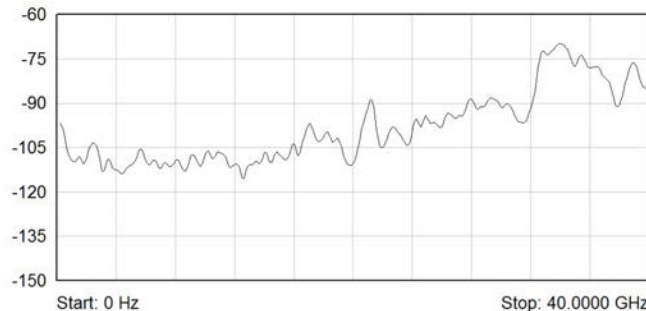

Typical Isolation (dB) Plot for 40 GHz Terminated Versions

## Specification - 50 GHz Underterminated & Terminated Versions

Characteristic Impedance:	50 $\Omega$
Connectors:	SMA-2.4
Bandwidth	DC to 50 GHz
Isolation:	70 dB (0-6 GHz) 60 dB (6-12.4 GHz) 60 dB (12.4-18 GHz) 55 dB (18-26.5 GHz) 50 dB (26.5-40 GHz) 50 dB (40-50 GHz)
Insertion Loss:	0.2 dB (0-6 GHz) 0.4 dB (6-12.4 GHz) 0.5 dB (12.4-18 GHz) 0.7 dB (18-26.5 GHz) 0.9 dB (26.5-40 GHz) 1.2 dB (40-50 GHz)
VSWR:	1.3:1 (0-6 GHz) 1.4:1 (6-12.4 GHz) 1.5:1 (12.4-18 GHz) 1.7:1 (18-26.5 GHz) 1.9:1 (26.5-40 GHz) 2.2:1 (40-50 GHz)
Maximum RF Carry Power:	40 W (0-6 GHz) 30 W (6-12.4 GHz) 25 W (12.4-18 GHz) 15 W (18-26.5 GHz) 5 W (26.5-40 GHz) 3 W (40-50 GHz)
Termination power rating:	1W per termination, 3 W total per 6 channel multiplexer
Expected Life (Low Power):	>2 million operations per position

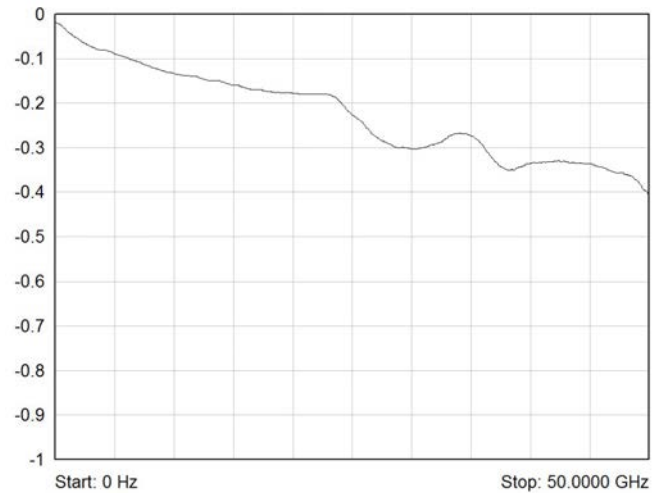

Typical Insertion Loss (dB) Plot for 50 GHz Terminated & Underterminated Versions

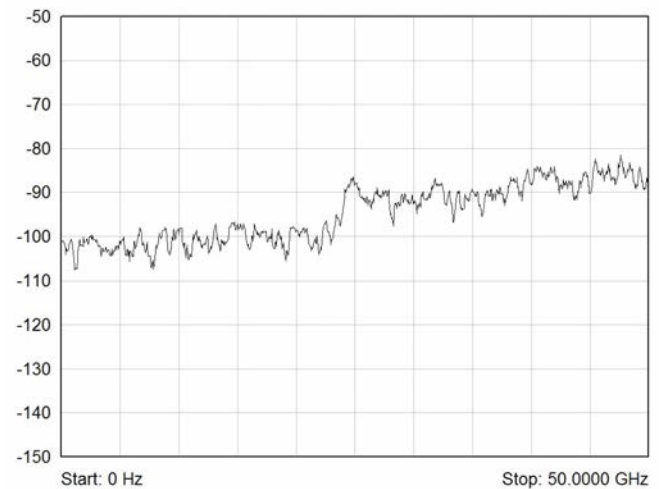

Typical Isolation (dB) Plot for 50 GHz Terminated & Underterminated Versions

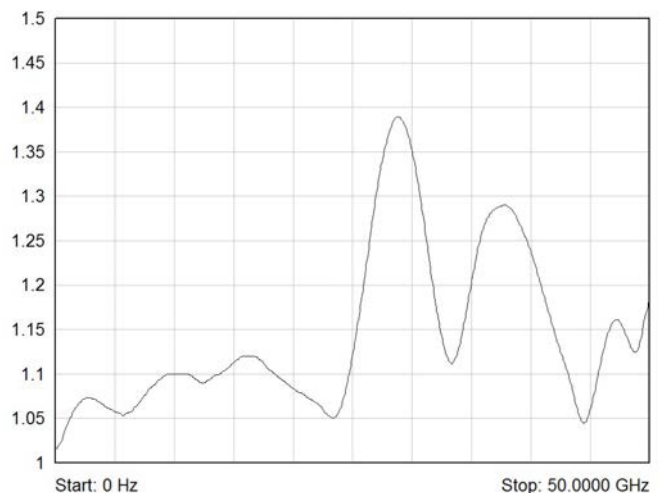

Typical VSWR Plot for 50 GHz Terminated & Underterminated Versions

## Specification - 67 GHz Underterminated Versions

Characteristic Impedance:	50 $\Omega$
Connectors:	SMA-1.85
Bandwidth	DC to 67 GHz
Isolation:	70 dB (0-6 GHz) 60 dB (6-12.4 GHz) 60 dB (12.4-18 GHz) 55 dB (18-26.5 GHz) 50 dB (26.5-40 GHz) 50 dB (40-50 GHz) 50 dB (50-65 GHz) 50 dB (65-67 GHz)
Insertion Loss:	0.3 dB (0-6 GHz) 0.4 dB (6-12.4 GHz) 0.5 dB (12.4-18 GHz) 0.7 dB (18-26.5 GHz) 0.9 dB (26.5-40 GHz) 1.2 dB (40-50 GHz) 1.2 dB (50-65 GHz) 1.7 dB (65-67 GHz)
VSWR:	1.3:1 (0-6 GHz) 1.4:1 (6-12.4 GHz) 1.5:1 (12.4-18 GHz) 1.7:1 (18-26.5 GHz) 1.9:1 (26.5-40 GHz) 2.2:1 (40-50 GHz) 2.2:1 (50-65 GHz) 2.2:1 (65-67 GHz)
Maximum RF Carry Power:	40 W (0-6 GHz) 30 W (6-12.4 GHz) 25 W (12.4-18 GHz) 15 W (18-26.5 GHz) 5 W (26.5-40 GHz) 3 W (40-50 GHz) 1 W (50-65 GHz) 1 W (65-67 GHz)
Expected Life (Low Power):	>2 million operations per position

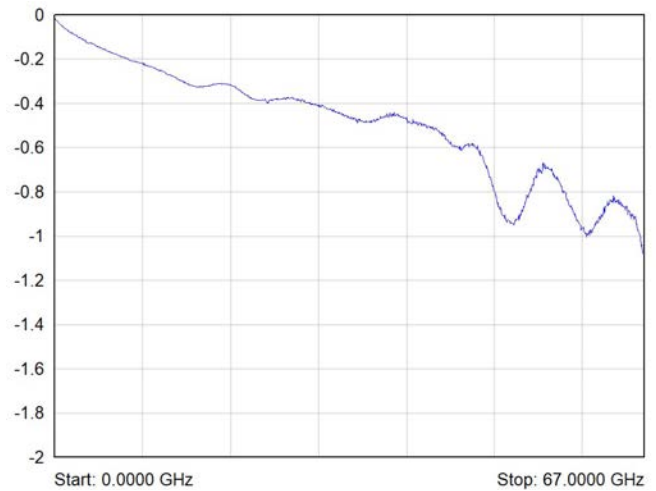

Typical Insertion Loss (dB) Plot for 67 GHz Underterminated Versions

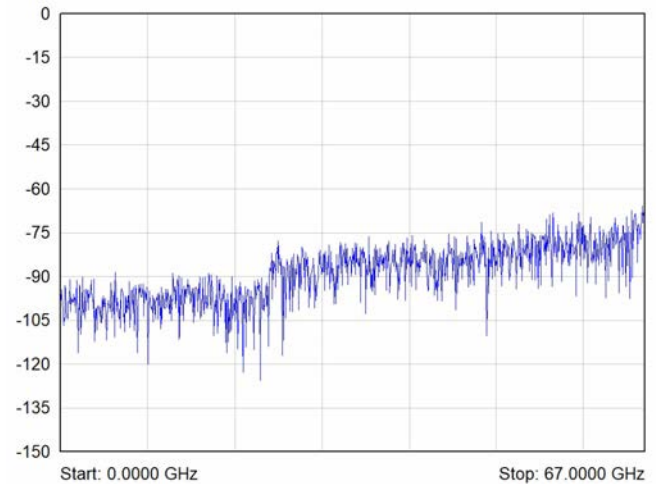

Typical Isolation (dB) Plot for 67 GHz Underterminated Versions

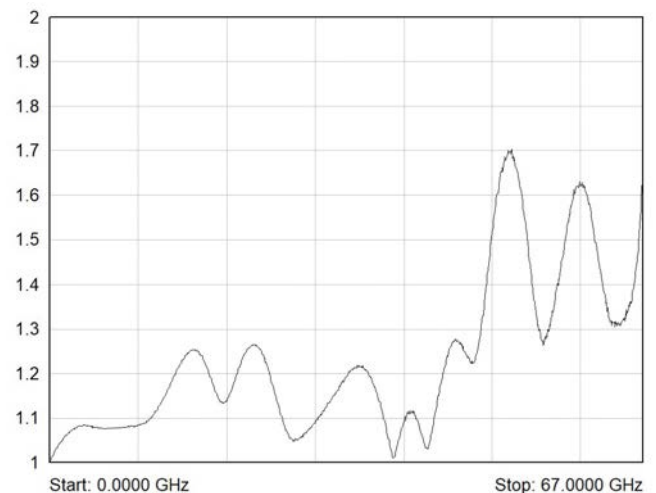

Typical VSWR Plot for 67 GHz Underterminated Versions

## Product Order Codes

LXI Microwave MUX, 50  $\Omega$ , Unterminated

6 to 1 MUX, 50 GHz, SMA-2.4	60-800-6xx
6 to 1 MUX, 67 GHz, SMA-1.85	60-800-8xx

Where xx defines the number of 6 to 1 multiplexers between 01-16 banks

LXI Microwave MUX, 50  $\Omega$ , Terminated

6 to 1 MUX, 18 GHz, SMA	60-800-1yy
6 to 1 MUX, 26.5 GHz, SMA	60-800-3yy
6 to 1 MUX, 40 GHz, SMA-2.92	60-800-5yy
6 to 1 MUX, 50 GHz, SMA-2.4	60-800-7yy

Where yy defines the number of 6 to 1 multiplexers between 01-14 banks

Versions with other bank counts, alternative connector types and different frequency ranges can be made to order, please contact sales office.

## Mating Connectors & Cabling

For connection accessories for the 60-800 please refer to the [90-011D](#) RF Cable Assemblies data sheet where a complete list and documentation can be found for accessories, or refer to our website.

## Product Customization

Pickering LXI units are designed and manufactured on our own flexible manufacturing lines, giving complete product control and enabling simple customization to meet very specific requirements.

Customization can include:

- Alternative relay types
- Mixture of relay types
- Alternative number of relays
- Different performance specifications

All customized products are given a unique part number, fully documented and may be ordered at any time in the future.

Please contact your local sales office to discuss.

## Product Order Codes Suggested Alternatives

The following products are available for all users but consideration should be given to the 60-801 (SP6T) and 60-802 (SP4T) product ranges. These ranges provide comparable performance to the 60-800 family for unterminated relays rated to 40 GHz with the advantages of reduced height (2U compared to 3U) for 9-16 40 GHz multiplexers plus LED indication for each multiplexer channel.

LXI Microwave MUX, 50  $\Omega$ , Unterminated

6 to 1 MUX, 18 GHz, SMA, 4-Banks	60-800-004
6 to 1 MUX, 18 GHz, SMA, 8-Banks	60-800-008
6 to 1 MUX, 18 GHz, SMA, 12-Banks	60-800-012
6 to 1 MUX, 18 GHz, SMA, 16-Banks	60-800-016

LXI Microwave MUX, 50  $\Omega$ , Unterminated 3U Chassis

6 to 1 MUX, 40 GHz, SMA, 16-Banks	60-800-416
-----------------------------------	------------

## Further LXI RF Switching Solutions from Pickering



60-891 LXI 36:1 Microwave MUX. Available With SMA Connectors (18 GHz) or BNC Connectors (4 GHz).



60-750/751 LXI Microwave Matrix. Bandwidth up to 20 GHz and is available in sizes from Single 3x3 up to Dual 4x4 with Loop-Thru and termination options.



60-801/802 LXI Microwave MUX, up to 40 GHz and support for up to 16 banks of 6 or 4 way multiplexers.



## Connectivity Solutions

We provide a full range of supporting cable and connector solutions for all our switching products—20 connector families with 1200+ products. We offer everything from simple mating connectors to complex cables assemblies and terminal blocks. All assemblies are manufactured by Pickering and are guaranteed to mechanically and electrically mate to our modules. These accessories are detailed in Connector Accessories data sheets, where a complete list and documentation can be found for each accessory.



Connectors & Backshells



Multi-way Cable Assemblies



RF Cable Assemblies



Breakouts



Connector Blocks

We also offer customized cabling and have a free online **Cable Design Tool** that can be used to create custom cable solutions for many applications.

- Fully supported on modern browsers and tablet operating systems.
- Built-in tutorials and videos allow you to get quickly up to speed.
- Store cable assemblies in the Cloud and develop over time.
- Each cable design has a downloadable PDF documentation file detailing all specifications

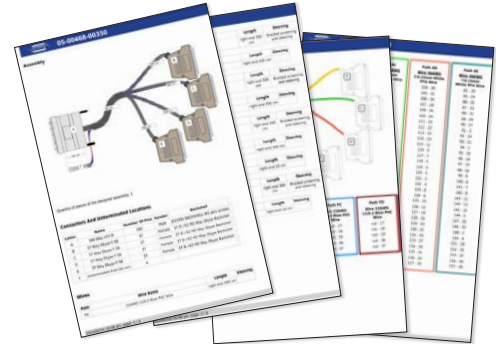

Start designing your custom cabling, go to [pickeringtest.com/cdt](http://pickeringtest.com/cdt)

## Mass Interconnect

We recommend the use of a mass interconnect solution when an Interchangeable Test Adapter (ITA) is required for PXI/LXI based test systems. Our modules are fully supported by Virginia Panel and MacPanel.

## Pickering Reed Relays

We are the only switch provider with in-house reed relay manufacturing capability via our Relay Division. These instrument grade reed relays feature **SoftCenter™** technology, ensuring long service life and repeatable contact performance.

To learn more go to [pickeringrelay.com](http://pickeringrelay.com)

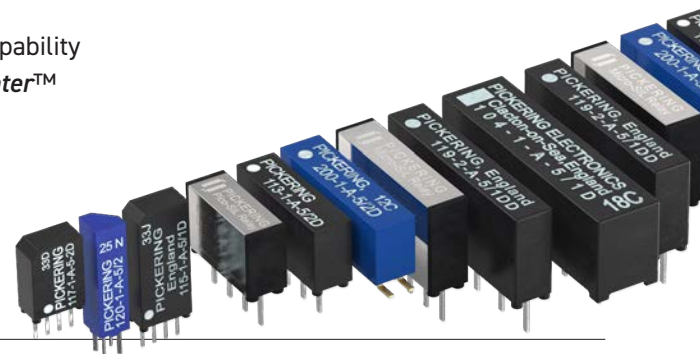

## Programming

Pickering provide kernel, IVI and VISA (NI & Keysight) drivers which are compatible with all Microsoft supported versions of Windows and popular older versions.

For more information go to [pickeringtest.com/os](http://pickeringtest.com/os)

The VISA driver support is provided for LabVIEW Real Time Operating Systems (Pharlap and Linux-RT). For other RTOS support contact Pickering. These drivers may be used with a variety of programming environments and applications including:

- **Pickering Interfaces Switch Path Manager**
- **National Instruments products** (LabVIEW, LabWindows/CVI, Switch Executive, MAX, TestStand, VeriStand, etc.)
- **Microsoft Visual Studio products** (Visual Basic, Visual C++)
- **Programming Languages** C, C++, C#, Python
- **Keysight VEE and OpenTAP**
- **Mathworks MATLAB, Simulink**
- **Marvin ATEasy**
- **MTQ Testsolutions Tecap Test & Measurement Suite**

Drivers for popular Linux distributions are available, other environments are also supported, please contact Pickering with specific enquiries. We provide Soft Front Panels (SFPs) for our products for familiarity and manual control, as well as comprehensive documentation and example programs to help you develop test routines with ease.

To learn more about software drivers and development environments go to [pickeringtest.com/software](http://pickeringtest.com/software)

## Signal Routing Software

Our signal routing software, Switch Path Manager, automatically selects and energizes switch paths through Pickering switching systems. Signal routing is performed by simply defining test system endpoints to be connected together, greatly accelerating Test System software development.

To learn more go to [pickeringtest.com/spm](http://pickeringtest.com/spm)

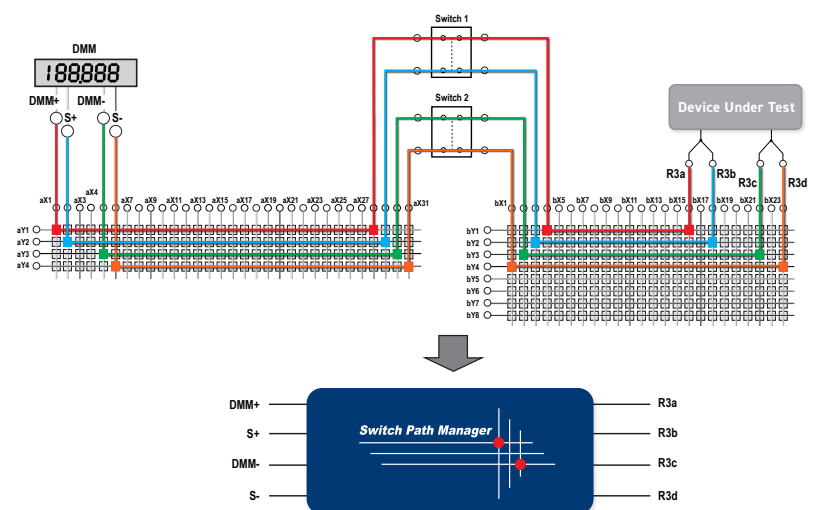

## Diagnostic Relay Test Tools

**eBIRST** Switching System Test Tools are designed specifically for our PXI, PCI or LXI products, these tools simplify switching system fault-finding by quickly testing the system and graphically identifying the faulty relay.

To learn more go to [pickeringtest.com/ebirst](http://pickeringtest.com/ebirst)



## Three Year Warranty & Guaranteed Long-Term Support

All standard products manufactured by Pickering Interfaces are warranted against defective materials and workmanship for three years from the date of delivery to the original purchaser. Extended warranty and service agreements are available with various levels for your requirements. Although we offer a 3-year warranty as standard, we also include guaranteed long-term support—with a history of supporting our products for typically 15-20 years.

To learn more go to [pickeringtest.com/support](http://pickeringtest.com/support)

## Available Product Resources

We have a library of resources including success stories, product and support videos, articles and white papers as well as application-specific brochures to assist you. We have also published reference books on switching technology and the PXI and LXI standards.

To view, download or request any of our product resources go to [pickeringtest.com/resources](http://pickeringtest.com/resources)

