

- Simulates Resistive Strain Gauge Bridge Circuits
- 6, 4 or 2 Simulators Per Card
- Simple Software Operation
- Fine Resistance Adjustment Over Full Operating Range
- VISA & Kernel Drivers Supplied for Windows
- 3 Year Warranty

The 50-265 card has 6, 4 or 2 simulation channels and is ideal for testing strain gauge meters in a wide variety of industrial control systems. It provides a simple way of replacing in house developed sensors with a low cost simulator that has excellent performance. The card uses the same resistor bridge techniques that real life strain gauges are based on, ensuring accurate emulation under all conditions.

Each channel includes an independent input for excitation voltage and a bridge output strain gauge simulation. The excitation voltage port can be driven by an AC or DC source. The bridge circuit includes three fixed resistors and a fourth programmable resistor that can be adjusted over a narrow range with fine setting capability and excellent accuracy. The adjustment range is sufficient to simulate quarter, half or full bridge circuits. The standard bridge impedances are 350 Ω , 1 k Ω , 1.5 k Ω , 2 k Ω and 3 k Ω .

The simulator is extremely easy to use, the variable resistor element of each channel can be programmed using a simple resistance call. The resistance required to balance the bridge can be read by the user, and the value sent to the simulator can be varied above and below the balance point to simulate extension and compression of a strain gauge.

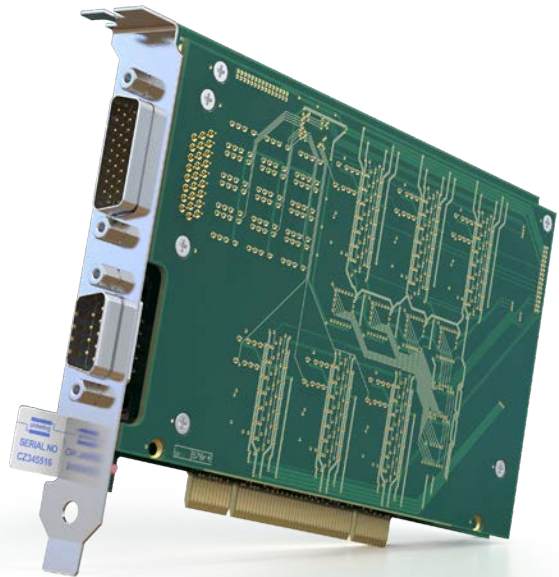

The 50-265 has a simple means of user verification using a DMM connected to the calibration port. Any of the channels can be selected and their functionality checked without disconnecting the card from the test system. The calibration port can also be used to find the bridge balance setting using the internal DC excitation source.

Adjustment is not routinely required thanks to the factory calibration information and the excellent long term stability of the bridge.

We can offer other models of strain gauge simulator and have a wide range of precision resistance modules that are suitable for simulating individual strain gauges. Please contact your local sales office for more information.

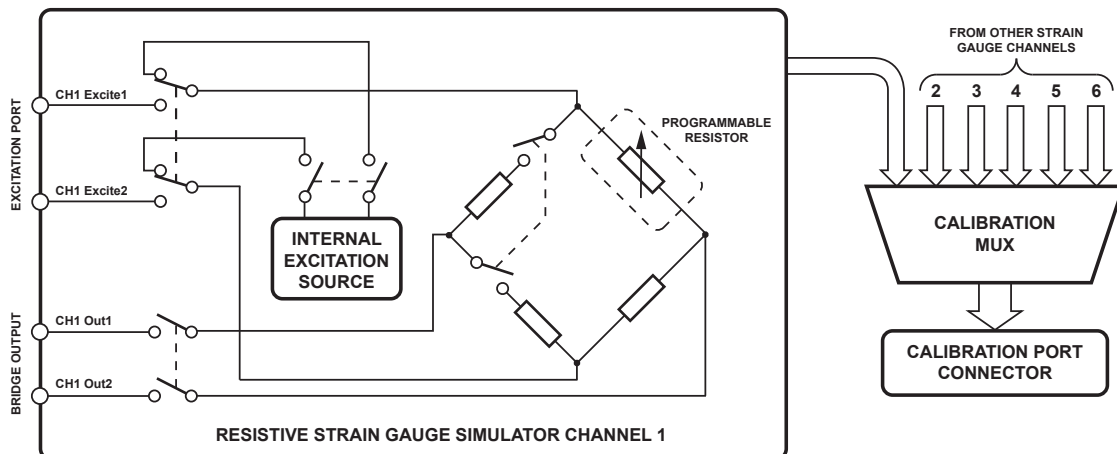

Functional Diagram for a single channel of the 50-265 Strain Gauge Simulator Card

Specifications

Strain Gauge Channels					
	50-265 -01x	50-265 -20x	50-265 -40x	50-265 -30x	50-265 -10x
Number of channels:	6, 4 or 2 per card				
Channel Configuration:	Independent excitation ports and bridge output.				
Resistor Values:	350 Ω	1 k Ω	1.5 k Ω	2 k Ω	3 k Ω
Variable Resistor:	$\pm 2\%$	$\pm 5.3\%$			
Resolution:	<2 m Ω	<10 m Ω	<12.5 m Ω	<20 m Ω	<25 m Ω
Variable Resistor Accuracy:	0.03 %	0.06 %			
Excitation Voltage*:	Up to ± 10 V peak (relative to ground) 20 V peak-to-peak, DC or AC †	Up to ± 12 V peak (relative to ground) 24 V peak-to-peak, DC or AC †			
Bridge Output:	> $\pm 0.45\%$ of excitation voltage ‡	> $\pm 1.25\%$ of excitation voltage ‡			

† Internal ± 5 V DC source can be used. Excitation port is disconnected when card power is off.

‡ Bridge Output disconnected when card power is off.

* For full voltage rating, signal sources must be fully isolated from mains supply and safety earth.

Calibration Port

Function: Allows connection to any of the strain gauge bridges. Provides a simple means of checking the operation of any of the strain gauges and finding bridge balance points when internal excitation source is selected. Can be used for module verification.

Also used by Pickering Interfaces for module adjustment.

Power Requirements

+3.3 V	+5 V	+12 V	-12 V
0.2 A	0.2 A (0.55 A Max)	0.1 A (0.2 A Max)	0.1 A

Software Support

Supplied with software that accepts a simple resistance instruction.

Mechanical Characteristics

Single slot short PCI format.

3D models for all versions in a variety of popular file formats are available on request.

Connectors

Strain gauge channel signals via a 26-pin male High Density D-Type connector. Calibration connection via a 9-pin male D-Type connector. For pin outs please refer to the operating manual.

PCI Compliance

The 50-265 complies with the PCI Specification 2.0 (issued Feb 2004).

Signalling Environment: 33 MHz, 32-bit Universal (+3.3 V or +5 V).

For advance information about a PCI Express version of this card please contact your local Pickering sales office

Supplied soft front panels and driver software are fully compatible with Windows operating systems.

Safety & CE Compliance

All cards are fully CE compliant and meet applicable EU directives:

Low-voltage safety EN61010-1:2010,
EMC Immunity EN61326-1:2013,
Emissions EN55011:2009+A1:2010.

The 50-265 uses innovative techniques which are the subject of protected Pickering Interfaces intellectual property rights.

Operating/Storage Conditions

Operating Temperature:	0 °C to +55 °C
Humidity:	Up to 90 % non-condensing
Altitude:	5000 m
Storage Temperature:	-20 °C to +75 °C
Humidity:	Up to 90 % non-condensing
Altitude:	15000 m

Product Order Codes

6 Channel Strain Gauge Simulator:	
350 Ω	50-265-016
1 kΩ	50-265-206
1.5 kΩ	50-265-406
2 kΩ	50-265-306
3 kΩ	50-265-106
4 Channel Strain Gauge Simulator:	
350 Ω	50-265-014
1 kΩ	50-265-204
1.5 kΩ	50-265-404
2 kΩ	50-265-304
3 kΩ	50-265-104
2 Channel Strain Gauge Simulator:	
350 Ω	50-265-012
1 kΩ	50-265-202
1.5 kΩ	50-265-402
2 kΩ	50-265-302
3 kΩ	50-265-102

Accessories:

Calibration port to DMM lead (shrouded 4mm bayonet plug):

for single module (1x9 pin D-type)	40-975-009-SL1
for two modules (2x9 pin D-types)	40-975-009-SL2
for three modules (3x9 pin D-types)	40-975-009-SL3

(calibration leads capable of supporting a greater number of cards are available, please contact sales office)

Mating Connectors & Cabling

For connection accessories for the 50-265 please refer to the [90-009D](#) 26-pin D-type and [90-003D](#) 9-pin D-type Connector Accessories data sheets where a complete list and documentation can be found for accessories.



Pickering can supply mating connectors and cable assemblies to enable easy integration of the 50-265 series of PCI cards

Product Customization

Pickering PCI cards are designed and manufactured on our own flexible manufacturing lines, giving complete product control and enabling simple customization to meet very specific requirements.

All customized products are given a unique part number, fully documented and may be ordered at any time in the future. Please contact your local sales office to discuss.

Other Resistor Modules

Pickering Interfaces manufacture a range of variable resistor cards in the PCI format. If you have a requirement for a variable resistor module please contact your local sales office with the information below and we will advise you on the best solution for your application.

Lowest Resistance †	<input type="text"/>
Highest Resistance	<input type="text"/>
Resistance Resolution	<input type="text"/>
Overall Accuracy	<input type="text"/>
Maximum Power/Current	<input type="text"/>
Number of Channels (variable resistors)	<input type="text"/>

† Resistance is as measured across the user connector terminals, minimum resistance must have a non-zero value.

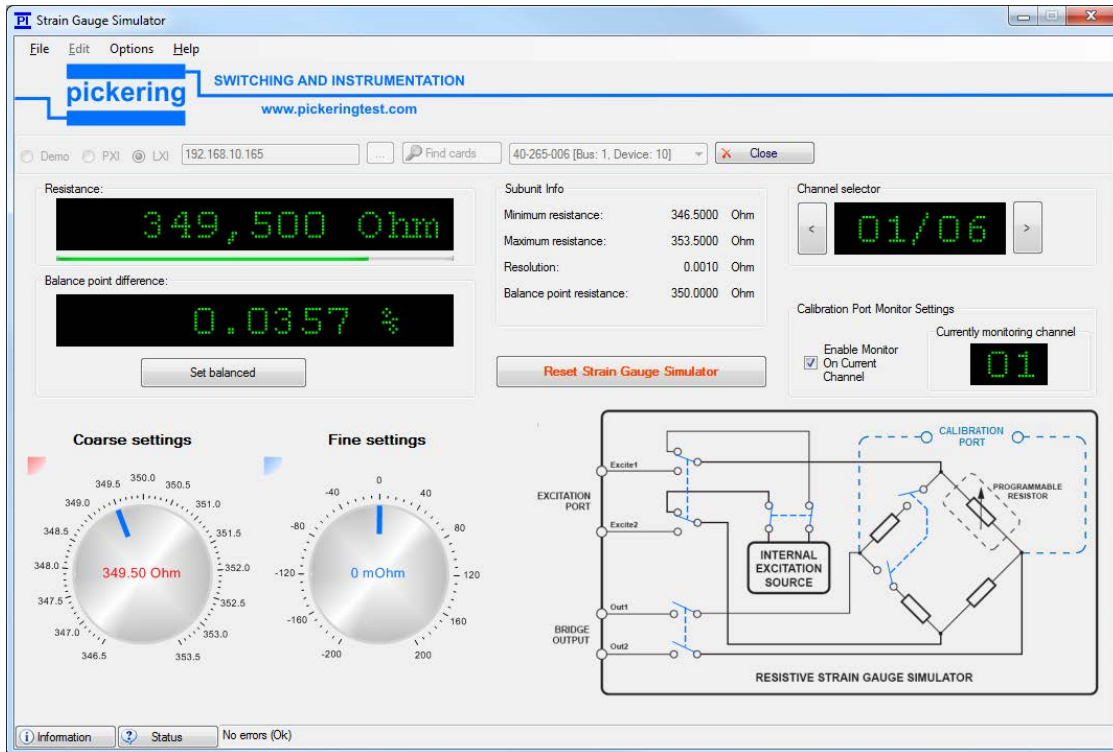

Soft Front Panel for the 50-265 Strain Gauge Simulator Module

Connectivity Solutions

We provide a full range of supporting cable and connector solutions for all our switching products—20 connector families with 1200+ products. We offer everything from simple mating connectors to complex cables assemblies and terminal blocks. All assemblies are manufactured by Pickering and are guaranteed to mechanically and electrically mate to our modules. These accessories are detailed in Connector Accessories data sheets, where a complete list and documentation can be found for each accessory.



Connectors & Backshells



Multi-way Cable Assemblies

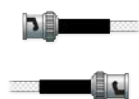

RF Cable Assemblies



Breakouts



Connector Blocks

We also offer customized cabling and have a free online **Cable Design Tool** that can be used to create custom cable solutions for many applications.

- Fully supported on modern browsers and tablet operating systems.
- Built-in tutorials and videos allow you to get quickly up to speed.
- Store cable assemblies in the Cloud and develop over time.
- Each cable design has a downloadable PDF documentation file detailing all specifications

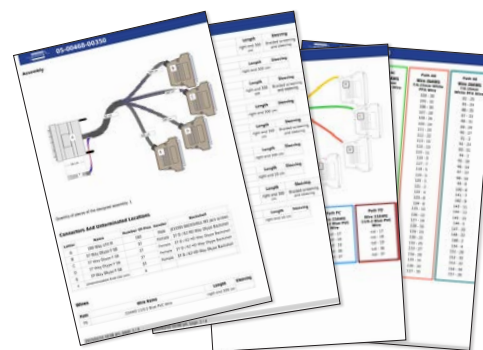

Start designing your custom cabling, go to pickeringtest.com/cdt

Mass Interconnect

We recommend the use of a mass interconnect solution when an Interchangeable Test Adapter (ITA) is required for PXI/LXI based test systems. Our modules are fully supported by Virginia Panel and MacPanel.

Pickering Reed Relays

We are the only switch provider with in-house reed relay manufacturing capability via our Relay Division. These instrument grade reed relays feature **SoftCenter™** technology, ensuring long service life and repeatable contact performance.

To learn more go to pickeringrelay.com

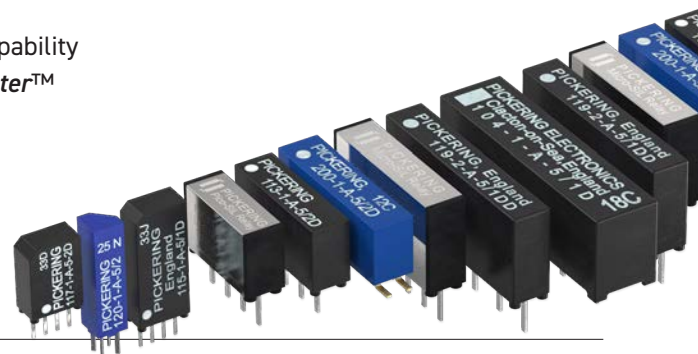

Programming

Pickering provide kernel, IVI and VISA (NI & Keysight) drivers which are compatible with all Microsoft supported versions of Windows and popular older versions.

For more information go to pickeringtest.com/os

The VISA driver support is provided for LabVIEW Real Time Operating Systems (Pharlap and Linux-RT). For other RTOS support contact Pickering. These drivers may be used with a variety of programming environments and applications including:

- **Pickering Interfaces Switch Path Manager**
- **National Instruments products** (LabVIEW, LabWindows/CVI, Switch Executive, MAX, TestStand, VeriStand, etc.)
- **Microsoft Visual Studio products** (Visual Basic, Visual C++)
- **Programming Languages** C, C++, C#, Python
- **Keysight VEE and OpenTAP**
- **Mathworks MATLAB, Simulink**
- **Marvin ATEasy**
- **MTQ Testsolutions Tecap Test & Measurement Suite**

Drivers for popular Linux distributions are available, other environments are also supported, please contact Pickering with specific enquiries. We provide Soft Front Panels (SFPs) for our products for familiarity and manual control, as well as comprehensive documentation and example programs to help you develop test routines with ease.

To learn more about software drivers and development environments go to pickeringtest.com/software

Signal Routing Software

Our signal routing software, Switch Path Manager, automatically selects and energizes switch paths through Pickering switching systems. Signal routing is performed by simply defining test system endpoints to be connected together, greatly accelerating Test System software development.

To learn more go to pickeringtest.com/spm

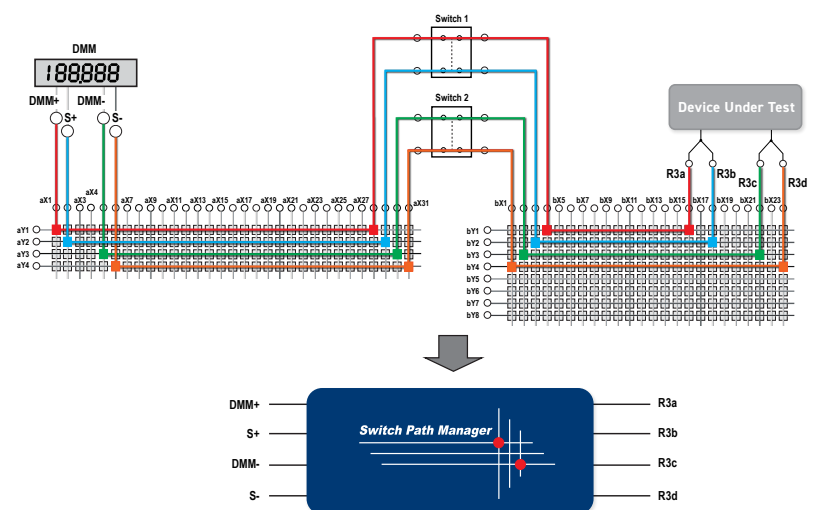

Diagnostic Relay Test Tools

eBIRST Switching System Test Tools are designed specifically for our PXI, PCI or LXI products, these tools simplify switching system fault-finding by quickly testing the system and graphically identifying the faulty relay.

To learn more go to pickeringtest.com/ebirst



Three Year Warranty & Guaranteed Long-Term Support

All standard products manufactured by Pickering Interfaces are warranted against defective materials and workmanship for three years from the date of delivery to the original purchaser. Extended warranty and service agreements are available with various levels for your requirements. Although we offer a 3-year warranty as standard, we also include guaranteed long-term support—with a history of supporting our products for typically 15-20 years.

To learn more go to pickeringtest.com/support

Available Product Resources

We have a library of resources including success stories, product and support videos, articles and white papers as well as application-specific brochures to assist you. We have also published reference books on switching technology and the PXI and LXI standards.

To view, download or request any of our product resources go to pickeringtest.com/resources

