

# PXI/PXIe Terminated SPDT Microwave Relays 4x-781A-92x

PRELIMINARY DATA

- Available as PXI or PXIe Modules
- 1 or 2 Changeover Relays Per Module
- External Termination
- 50  $\Omega$  Characteristic Impedance
- 110 GHz Bandwidth
- Latching Relays
- 0.5 M Operations
- Relay Cycle Counting Included
- Drivers Supplied for Windows & Linux, Plus Support for Real-time Systems
- PXI Version Supported by PXI or LXI Chassis
- 1 Year Warranty



The 40-781A-92x (PXI) and 42-781A-92x (PXIe) modules consist of one, or two microwave changeover switches capable of switching up to 110 GHz in 50  $\Omega$ . They are available with external terminations and connections are via front panel mounted high quality SMA 1.0 connectors.

Externally terminated switches have the advantage that the terminations can be removed and replaced with higher power RF loads. This also allows alternative configurations such as terminated 4-port bypass (1 termination removed) and 5-port DP3T (both terminations removed). See overleaf for diagrams of these configurations.

The 4x-781A gives you the highest RF switching performance available within a Pickering switching system. Although designed for microwave applications, they have many uses in the RF spectrum where extremely low insertion loss and ultra high isolation are critical. They may also be used at lower frequencies where power handling to 35 W (without termination) is required.

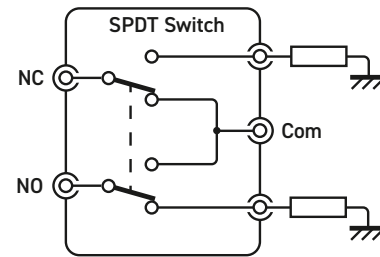

Microwave Switch (Part No. 4x-781A-921-LA) in Single SPDT Format

## Product Compatibility

The 4x-781A range has been introduced as an update to the existing 40-781 family. These remain orderable but the new 4x-781A is recommended as it provides additional options such as the PXIe control interface. The RF performance of the 4x-781A is identical to the 40-781.

## Relay Type

This range of modules is fitted with latching relays. For definition, latching relay contacts retain their last set state when the power is removed.

## Relay Cycle Counting

To aid with module "health" monitoring all versions are provided with a relay cycle counting feature. The number of operations per contact are stored on the module and can be used to determine if a relay is approaching EOL. This information could allow system connections to be revised so that signals applied to heavily used contacts are swapped with lightly used contacts to prolong the working life of the relay(s).

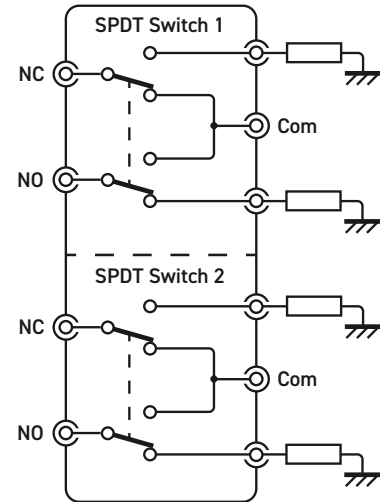

Microwave Switch (Part No. 4x-781A-922-LA) in Dual SPDT Format

## Alternative Configurations for Externally Terminated Versions

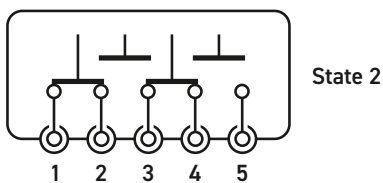
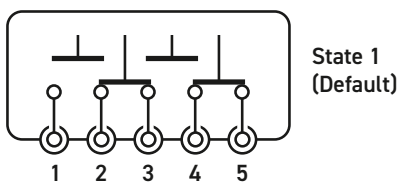

Configured as a 5-Port DP3T Switch (With Both External Terminations Removed)

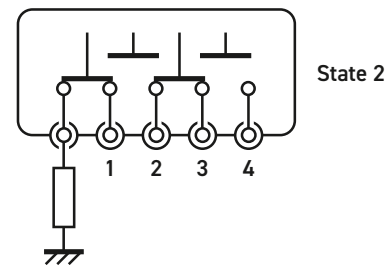
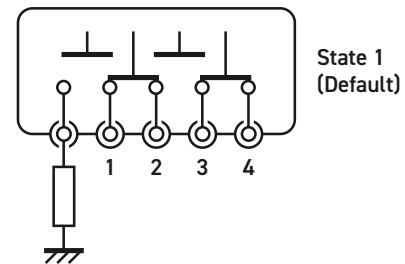

Configured as a Terminated 4-Port Bypass Switch (With One External Termination Removed)

## Specifications - 110 GHz Versions

Characteristic Impedance:	50 $\Omega$
Connector Type:	SMA 1.0
Insertion Loss:	<0.8 dB to 20 GHz <1.4 dB to 50 GHz <1.8 dB to 67 GHz <2.2 dB to 90 GHz <2.5 dB to 110 GHz
Isolation:	>70 dB to 20 GHz >70 dB to 50 GHz >60 dB to 67 GHz >60 dB to 90 GHz >50 dB to 110 GHz
VSWR:	<1.5:1 to 20 GHz <1.8:1 to 50 GHz <1.9:1 to 67 GHz <2.0:1 to 90 GHz <2.2:1 to 110 GHz
Repeatability:	0.15 dB (Maximum)
Power Handling - External Terminations:	1 W limited by terminations.
<b>Note:</b> External terminations can be removed and replaced with higher power loads.	
RF Average Carry Power at 25 °C:	35 W to 18 GHz 10 W to 40 GHz 3 W to 67 GHz 2 W to 90 GHz 1 W to 110 GHz
Operate Time:	20 ms
Expected Life:	0.5 million operations

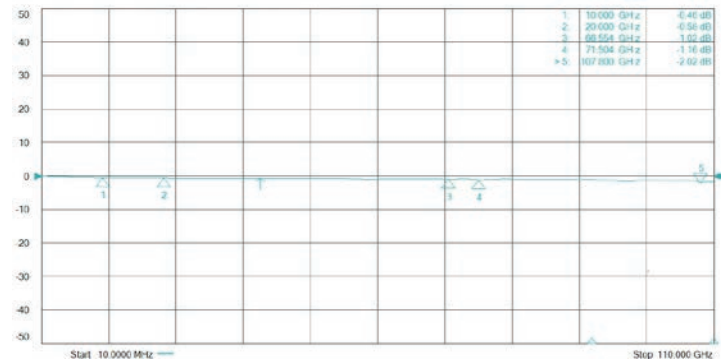

Typical Insertion Loss - 110 GHz Versions

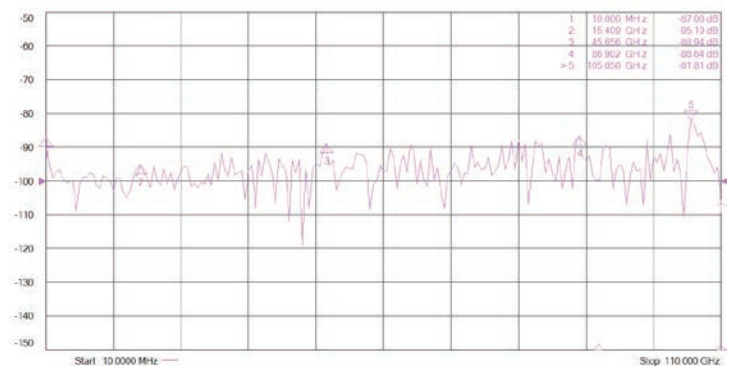

Typical Isolation - 110 GHz Versions

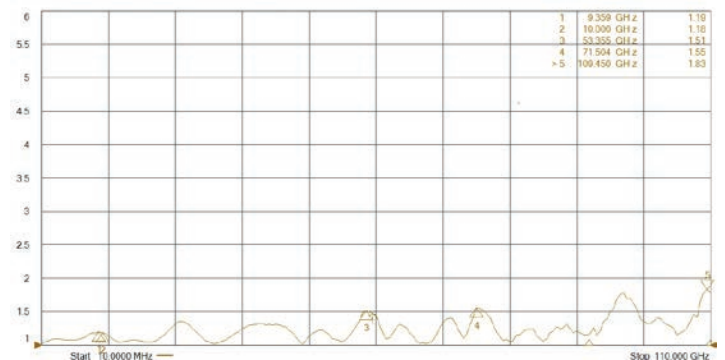

Typical VSWR - 110 GHz Versions

PRELIMINARY DATA

## General Specification

Configuration:	SPDT Microwave Switch with automatic termination on the NO and NC paths, 1 or 2 independent banks.
----------------	--

## Power Requirements - 40-781A

+3.3V	+5V	+12V	-12V
TBD	TBD	TBD	0

## Power Requirements - 42-781A

+3.3V	+12V
TBD	TBD

## Mechanical Characteristics

- 40-781A single SPDT
  - Single slot 3U PXI (CompactPCI card)
- 40-781A dual SPDT
  - Double slot 3U PXI (CompactPCI card)
- 42-781A single SPDT
  - Single slot 3U PXIe, compatible with PXIe hybrid slot
- 42-781A dual SPDT
  - Double slot 3U PXIe, compatible with PXIe hybrid slot

3D models for all versions in a variety of popular file formats are available on request.

## Connectors

40-781A - PXI bus via 32-bit P1/J1 backplane connector.

42-781A - PXIe bus via XJ3 and XJ4 backplane connectors.

Signals via front panel mounted 50 Ω SMA 1.0 connectors.

## Operating/Storage Conditions

Operating Temperature: 0 °C to +55 °C  
 Humidity: Up to 90 % non-condensing  
 Altitude: 5000 m

Storage Temperature: -20 °C to +75 °C  
 Humidity: Up to 90 % non-condensing  
 Altitude: 15000 m

## Product Order Codes

PXI Microwave Relay Module, 110 GHz, 50 Ω, SMA 1.0	
Single SPDT, External Terminations, Latching	40-781A-921-LA
Dual SPDT, External Terminations, Latching	40-781A-922-LA
PXIe Microwave Relay Module, 110 GHz, 50 Ω, SMA 1.0	
Single SPDT, External Terminations, Latching	42-781A-921-LA
Dual SPDT, External Terminations, Latching	42-781A-922-LA

## Warranty

This module carries a 1 year warranty. The warranty specifically applies to only the cold switching operations of the relay within the stated lifetime.

PRELIMINARY DATA

PRELIMINARY DATA

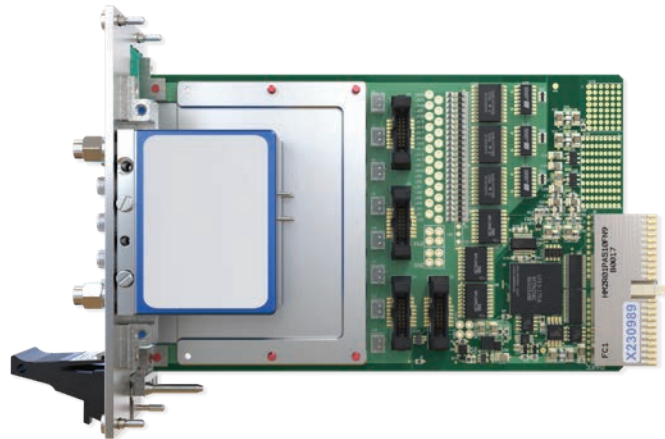

Side View of the PXI Dual Externally Terminated Microwave Switch

## Product Customization

Pickering modules are designed and manufactured on our own flexible manufacturing lines, giving complete product control and enabling simple customization to meet very specific requirements. Customization can include:

- Alternative relay types
- Mixture of relay types
- Alternative number of relays
- Different performance specifications

All customized products are given a unique part number, fully documented and may be ordered at any time in the future. Please contact your local sales office to discuss.



42-781A-922-LA PXIe Dual SPDT Microwave Switch with External Termination

## PXI & CompactPCI Compliance - 40-781A

The module is compliant with the PXI Specification 2.2. Local Bus, Trigger Bus and Star Trigger are not implemented.

Uses a 33 MHz 32-bit backplane interface.

## PXIe Compliance - 42-781A

The module is compliant with the PXIe Specification 1.0. Local Bus, Trigger Bus & Star Trigger are not implemented.

## Safety & CE Compliance

All modules are fully CE compliant and meet applicable EU directives:

Low-voltage safety EN61010-1:2010,  
EMC Immunity EN61326-1:2013,  
Emissions EN55011:2009+A1:2010.

# PXI/PXIe Terminated SPDT Microwave Relays 4x-781A-92x

The 4x-781A is part of a range of switching modules suitable for RF and microwave applications.

## Pickering's Range of PXI & PXIe Microwave Switching Modules

Switch Type	Banks	Frequency Range	Model No.
SPDT Unterminated	1, 2, 3 or 4 Panel Mount, 1, 2 or 3 Remote Mount	2.5 GHz (75 Ω) or 12.4 - 67 GHz (50 Ω)	4x-780B
SPDT Terminated	1 or 2 Panel Mount	18 - 110 GHz (50 Ω)	4x-781A
Transfer Switch	1 or 2 Panel Mount	18 - 50 GHz (50 Ω)	4x-782B
SP4T or SP6T Unterminated	1, 2 or 3 Panel Mount, 1, 2 or 3 Remote Mount	6 - 40 GHz (50 Ω)	4x-784B
SP4T or SP6T Terminated or Unterminated	1 or 2 Panel Mount, 1, 2 or 3 Remote Mount	2.5 GHz (75 Ω) or 3 - 67 GHz (50 Ω)	4x-785C
SP8T, SP10T or SP12T Terminated or Unterminated	1 or 2 Panel Mount, 1 or 2 Remote Mount	8 - 26.5 GHz (50 Ω)	4x-788



4x-780B

4x-781A

4x-782B

4x-784B

4x-785C

4x-788

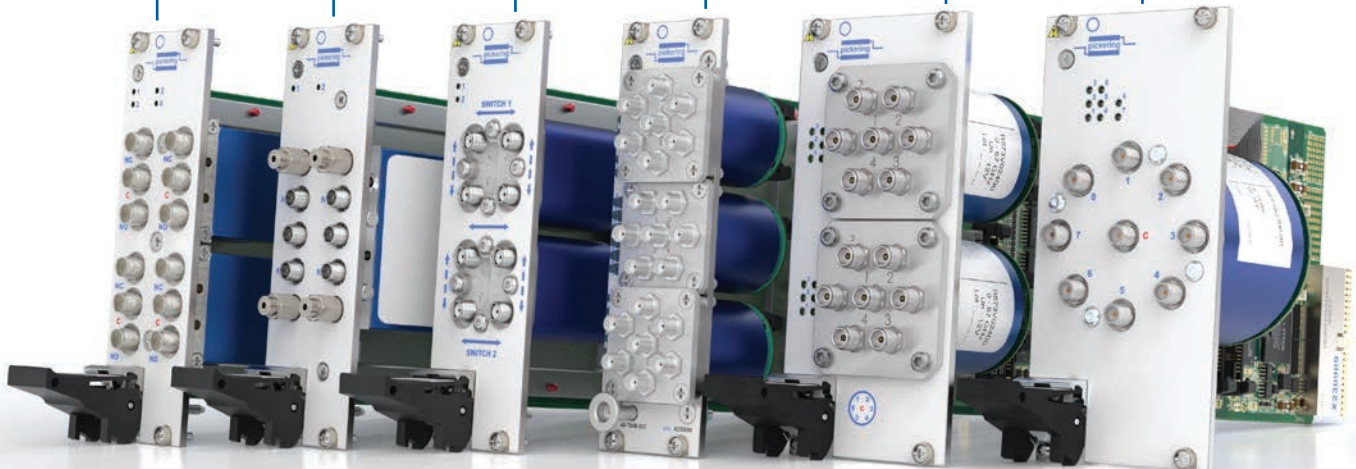

PRELIMINARY DATA

## Chassis Compatibility

The PXI versions of this module are compatible with the following chassis types:

- All chassis conforming to the 3U PXI and 3U Compact PCI (cPCI) specification
- Legacy and Hybrid Peripheral slots in a 3U PXI Express (PXIe) chassis
- Pickering Interfaces LXI or LXI/USB Modular Chassis

The PXIe versions of this module are compatible with the following chassis types:

- All chassis conforming to the 3U PXIe specification
- PXIe and Hybrid Peripheral slots in a 3U PXI Express (PXIe) chassis

## Chassis Selection Guide

### PXI and PXIe (with PXIe and/or Hybrid slots) Chassis from any Vendor:

- Mix our 1000+ PXI/PXIe switching & simulation modules with any vendor's PXI/PXIe instrumentation
- Embedded or remote Windows PC control
- Real-time Operating System Support
- High data bandwidths, especially with PXI Express
- Integrated module timing and synchronization



**PXI**

### Pickering LXI or LXI/USB Modular Chassis Only accept our PXI Switching & Simulation Modules:

- Choose from 1000+ Pickering PXI Modules
- Ethernet or USB control enables remote operation
- Low-cost control from practically any controller
- LXI provides manual control via Web browsers
- Driverless software support
- Power sequencing immunity
- Ethernet provides chassis/controller voltage isolation
- Independence from Windows operating system



**LXI**

**LXI USB**

## Connectivity Solutions

We provide a full range of supporting cable and connector solutions for all our switching products—20 connector families with 1200+ products. We offer everything from simple mating connectors to complex cables assemblies and terminal blocks. All assemblies are manufactured by Pickering and are guaranteed to mechanically and electrically mate to our modules. These accessories are detailed in Connector Accessories data sheets, where a complete list and documentation can be found for each accessory.

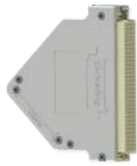

Connectors & Backshells



Multi-way Cable Assemblies

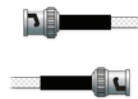

RF Cable Assemblies



Breakouts



Connector Blocks

We also offer customized cabling and have a free online **Cable Design Tool** that can be used to create custom cable solutions for many applications.

- Fully supported on modern browsers and tablet operating systems.
- Built-in tutorials and videos allow you to get quickly up to speed.
- Store cable assemblies in the Cloud and develop over time.
- Each cable design has a downloadable PDF documentation file detailing all specifications

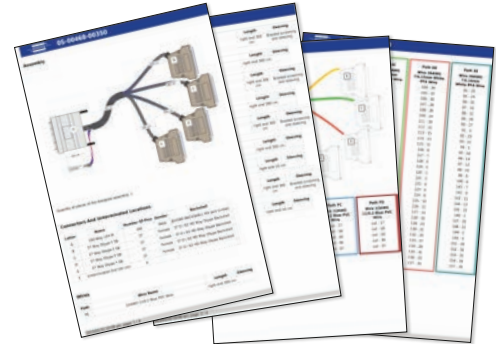

Start designing your custom cabling, go to [pickeringtest.com/cdt](http://pickeringtest.com/cdt)

## Mass Interconnect

We recommend the use of a mass interconnect solution when an Interchangeable Test Adapter (ITA) is required for PXI/LXI based test systems. Our modules are fully supported by Virginia Panel and MacPanel.

## Pickering Reed Relays

We are the only switch provider with in-house reed relay manufacturing capability via our Relay Division. These instrument grade reed relays feature **SoftCenter™** technology, ensuring long service life and repeatable contact performance.

To learn more go to [pickeringrelay.com](http://pickeringrelay.com)

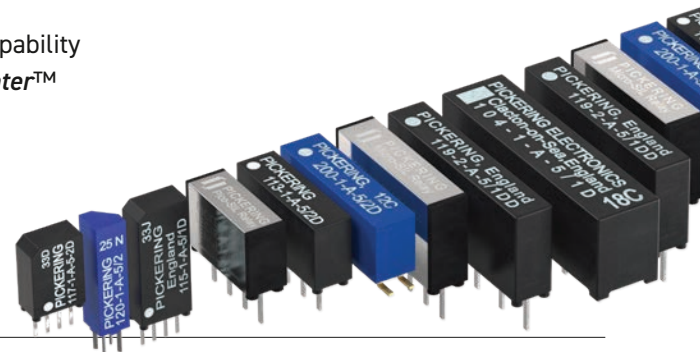

PRELIMINARY DATA



## Programming

Pickering provide kernel, IVI and VISA (NI & Keysight) drivers which are compatible with all Microsoft supported versions of Windows and popular older versions.

For more information go to [pickeringtest.com/os](http://pickeringtest.com/os)

The VISA driver support is provided for LabVIEW Real Time Operating Systems (Pharlap and Linux-RT). For other RTOS support contact Pickering. These drivers may be used with a variety of programming environments and applications including:

- Pickering Interfaces Switch Path Manager
- National Instruments products (LabVIEW, LabWindows/CVI, Switch Executive, MAX, TestStand, VeriStand, etc.)
- Microsoft Visual Studio products (Visual Basic, Visual C++)
- Programming Languages C, C++, C#, Python
- Keysight VEE and OpenTAP
- Mathworks MATLAB, Simulink
- Marvin ATEasy
- MTQ Testsolutions Tecap Test & Measurement Suite

Drivers for popular Linux distributions are available, other environments are also supported, please contact Pickering with specific enquiries. We provide Soft Front Panels (SFPs) for our products for familiarity and manual control, as well as comprehensive documentation and example programs to help you develop test routines with ease.

To learn more about software drivers and development environments go to [pickeringtest.com/software](http://pickeringtest.com/software)

## Signal Routing Software

Our signal routing software, Switch Path Manager, automatically selects and energizes switch paths through Pickering switching systems. Signal routing is performed by simply defining test system endpoints to be connected together, greatly accelerating Test System software development.

To learn more go to [pickeringtest.com/spm](http://pickeringtest.com/spm)

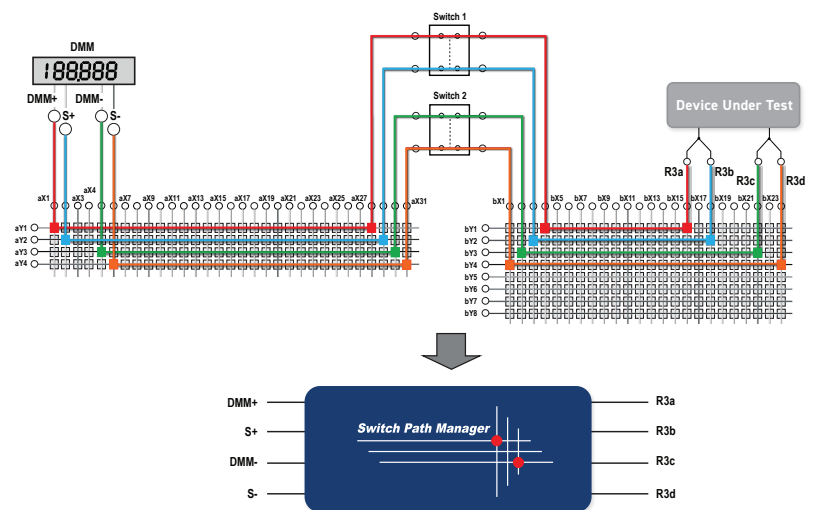

PRELIMINARY DATA

## Diagnostic Relay Test Tools

eBIRST Switching System Test Tools are designed specifically for our PXI, PCI or LXI products, these tools simplify switching system fault-finding by quickly testing the system and graphically identifying the faulty relay.

To learn more go to [pickeringtest.com/ebirst](http://pickeringtest.com/ebirst)



## Three Year Warranty & Guaranteed Long-Term Support

All standard products manufactured by Pickering Interfaces are warranted against defective materials and workmanship for three years from the date of delivery to the original purchaser. Extended warranty and service agreements are available with various levels for your requirements. Although we offer a 3-year warranty as standard, we also include guaranteed long-term support—with a history of supporting our products for typically 15-20 years.

To learn more go to [pickeringtest.com/support](http://pickeringtest.com/support)

## Available Product Resources

We have a library of resources including success stories, product and support videos, articles and white papers as well as application-specific brochures to assist you. We have also published reference books on switching technology and the PXI and LXI standards.

To view, download or request any of our product resources go to [pickeringtest.com/resources](http://pickeringtest.com/resources)

